

ASPHERIC COEFFICIENTS

	R	k	A4
S1	4.185	-0.6027	2.21E-4
S2	PLANO	-	-

$$z = \frac{Y^2}{R(1 + \sqrt{1 - (1 + k)Y^2/R^2})} + A_4Y^4$$

ASPHERIC LENS EQUATION

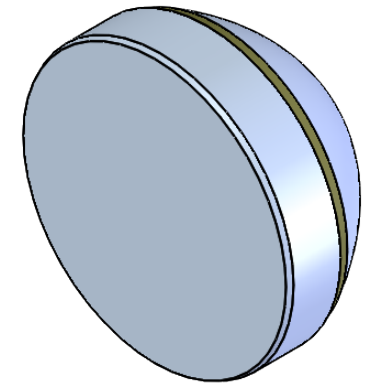
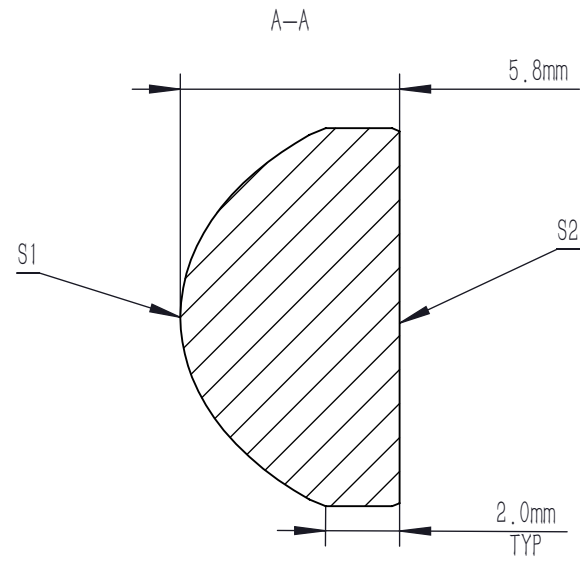
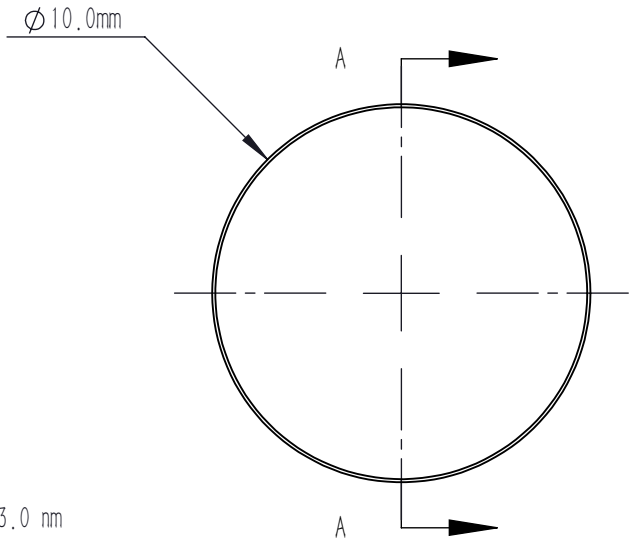

NOTES

1. MATERIAL: B270
2. DESIGN WAVELENGTH: 633.0 nm
3. WORKING WAVELENGTH: 700 nm-1100 nm
4. NUMERICAL APERTURE: 0.61
5. F/#: 0.89
6. FOCAL LENGTH: 8.0 mm
7. FOCAL LENGTH TOLERANCE: ±8%
8. BACK FOCAL LENGTH(REF): bf=4.0 mm
9. CLEAR APERTURE: >90%CA
10. DIAMETER TOLERANCE: +0.0/-0.5 mm
11. THICKNESS TOLERANCE: ±0.3 mm
12. CHAMFER: 0.2 mm, 45°
13. SURFACE QUALITY: 80-50 SCRATCH-DIG
14. CENTRATION: <30 arcmin
15. MAXIMUM TEMPERATURE: 250 °C(482 °F)
16. AR COATING: Ravg<0.5% @ 700 nm-1100 nm, 6° AOI

DRAWING PROJECTION			LBTEK			
	NAME	DATE	AC4101-B			
DRAWN	BSHU	Aug./1st/24	Ø 10.0 mm, F=8.0 mm, NA=0.61 ASPHERIC CONDENSER LENS AR COATING 700-1100 nm			
APPROVAL	WCHENG	Aug./1st/24	MATERIAL	WEIGHT	SCALE	REV
FOR INFORMATION ONLY NOT FOR MANUFACTURING PURPOSES			B270	0.78g	5:1	A