

	R	k	A4	A6	A8	A10	A12	A14	A16
S1	15.54	-1.35	2.362e-05	-1.130e-08	-1.111e-11	-2.398e-14	3.036e-17	1.366e-19	-1.888e-22
S2	INFINITE	-	-	-	-	-	-	-	-

$$Z = \frac{Y^2}{R(1 + \sqrt{1 - (1 + K)Y^2 / R^2})} + A_4 Y^4 + A_6 Y^6 + A_8 Y^8 + A_{10} Y^{10} + A_{12} Y^{12} + A_{14} Y^{14} + A_{16} Y^{16}$$

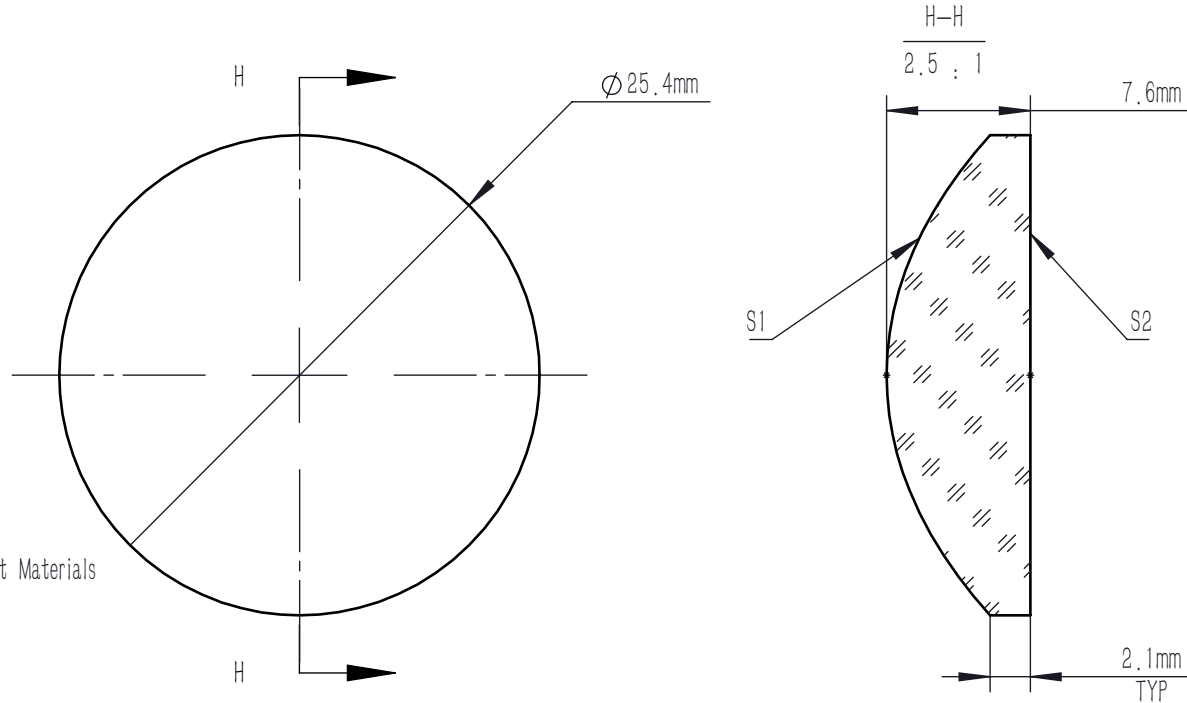
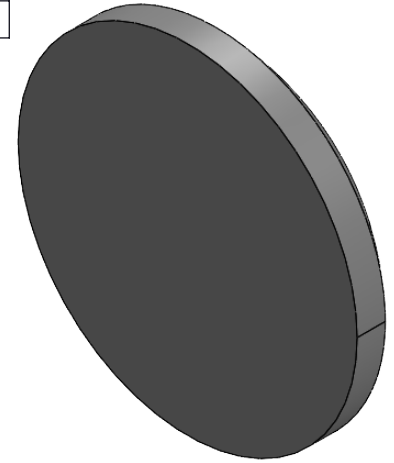

NOTES:

1. MATERIAL: S-LAH64, or Equivalent Materials
2. DESIGN WAVELENGTH: 780.0 nm
3. NUMERICAL APERTURE: 0.50
4. FOCAL LENGTH: 20 mm
5. FOCAL LENGTH TOLERANCE: $\pm 1\%$
6. BACK FOCAL LENGTH(REF): BF=15.7 mm
7. CLEAR APERTURE: $>90\%$ CA
8. DIAMETER TOLERANCE: $+0.0/-0.1$ mm
9. THICKNESS TOLERANCE: ± 0.1 mm
10. CHAMFER: 0.2 mm, 45°
11. WAVEFRONT ERROR(RMS): $<0.5 \mu\text{m}$
12. SAG DEVIATION(POWER, S1): $\pm 7.5 \mu\text{m}$
13. SURFACE IRREGULARITY(S1): <3 FRINGES
14. SURFACE FLATNESS(S2): $\lambda/4$
15. SURFACE QUALITY(S/D): 60/40
16. CENTRATION: <3 arcmin
17. AR COATING (S1, S2): UNCOATED

DRAWING PROJECTION			LBTEK			
	NAME	DATE	AC7606			
DRAWN	ZLIN	Nov./15th/25	ASPHERIC LENS			
APPROVAL	WCHENG	Nov./15th/25	MATERIAL	WEIGHT	SCALE	REV
FOR INFORMATION ONLY NOT FOR MANUFACTURING PURPOSES			S-LAH64	10.69g	2.5:1	A