

Ø 11.00mm

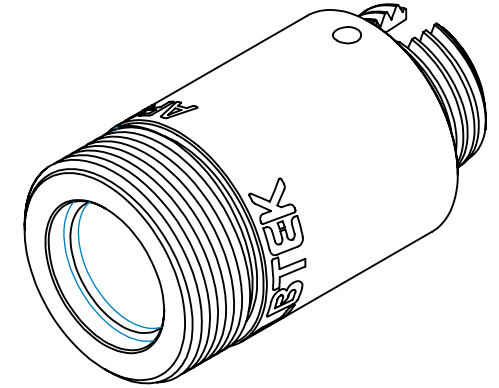
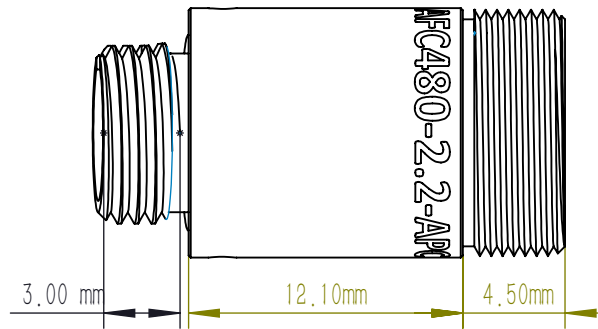
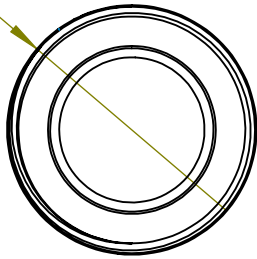

NOTE

1. OUTPUT BEAM DIAMETER: 2.2 mm
2. FULL ANGLE BEAM DIVERGENCE: $\leq 0.03^\circ$
3. AR COATING: 400 nm–700 nm
4. WAVELENGTH USED FOR ALIGNMENT : 480 nm
5. USE INTERFACES: FC/APC

DRAWING
PROJECTION



LBTEK

	NAME	DATE	AFC480-2.2-APC			
DRAWN	BSHU	Aug./26th/24	$\lambda = 480$ nm FC/APC BEAM DIAMETER: 2.2 mm			
APPROVAL	WCHENG	Aug./26th/24	MATERIAL	WEIGHT	SCALE	REV
FOR INFORMATION ONLY NOT FOR MANUFACTURING PURPOSES			D-ZK3	13.5 g	2:1	B