

Ø 11.00mm

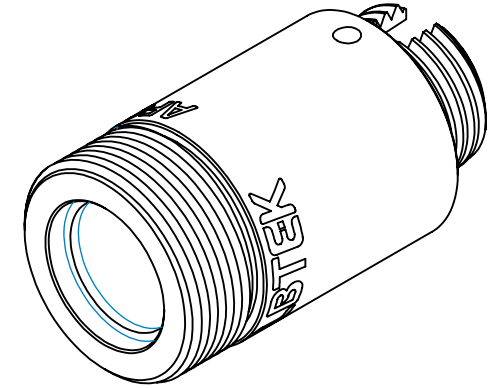
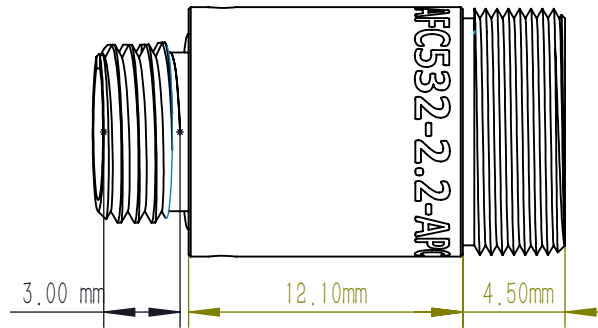
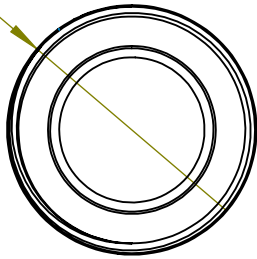

NOTE

1. OUTPUT BEAM DIAMETER: 2.2 mm
2. FULL ANGLE BEAM DIVERGENCE:  $\leq 0.03^\circ$
3. AR COATING: 400 nm–700 nm
4. WAVELENGTH USED FOR ALIGNMENT : 532 nm
5. USE INTERFACES: FC/APC

DRAWING  
PROJECTION



**LBTEK**

	NAME	DATE	AFC532-2.2-APC			
DRAWN	BSHU	Aug./26th/24	$\lambda = 532$ nm FC/APC BEAM DIAMETER: 2.2 mm			
APPROVAL	WCHENG	Aug./26th/24	MATERIAL	WEIGHT	SCALE	REV
FOR INFORMATION ONLY NOT FOR MANUFACTURING PURPOSES			D-ZK3	13.5 g	2:1	B