

Ø 11.00mm

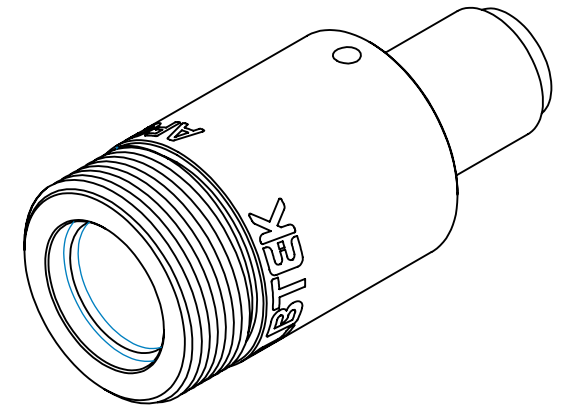
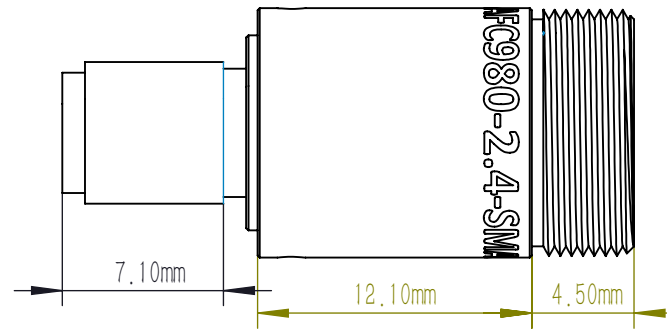
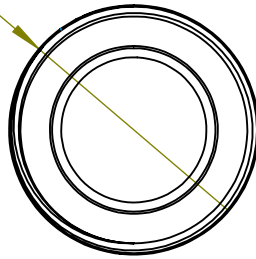

NOTE

1. OUTPUT BEAM DIAMETER: 2.4 mm
2. FULL ANGLE BEAM DIVERGENCE: $\leq 0.04^\circ$
3. AR COATING: 700 nm–1100 nm
4. WAVELENGTH USED FOR ALIGNMENT : 980 nm
5. USE INTERFACES: SMA

DRAWING PROJECTION			LBTEK			
	NAME	DATE	AFC980-2.4-SMA			
DRAWN	BSHU	Aug. /26th/24	$\lambda = 980$ mm SMA BEAM DIAMETER: 2.4 mm			
APPROVAL	WCHENG	Aug. /26th/24	MATERIAL	WEIGHT	SCALE	REV
FOR INFORMATION ONLY NOT FOR MANUFACTURING PURPOSES			D-ZK3	13.5 g	2:1	B