

SCALE 2: 1

NOTES

1. CLEAR APERTURE: >80%CA
2. AR COATING(S1,S2,S3,S4): RAVG<0.5% @1100 nm-1650 nm(6° AOI,SINGLE SURFACE)
3. DIAMETER TOLERANCE: +0.0/-0.2 mm
4. ANGLE TOLERANCE: ±1'
5. COATING(S5):
 $T_{abs}=(47 \pm 10)\%$, $R_{abs}=(47 \pm 10)\%$, $T_{abs}+R_{abs}>85\%$
 $|T_s-T_p| < 10\%$, $|R_s-R_p| < 10\%$
6. GLUED(S5,S6): NOA61
7. SPLIT RATIO(R:T): 50:50
8. TRANSMITTED BEAM DEVIATION: $0^\circ \pm 5$ arcmin
9. REFLECTED BEAM DEVIATION: $90^\circ \pm 5$ arcmin
10. SURFACE QUALITY(S1,S2,S3,S4): 40/20(S/D)
11. WAVEFRONT ERROR(RMS): $\lambda/4@633$ nm
12. SURFACE FLATNESS(S1,S2,S3,S4): $\lambda/10@633$ nm
13. OTHER SURFACES: FINE GROUND
14. CHAMFER: 0.2 mm, 45°

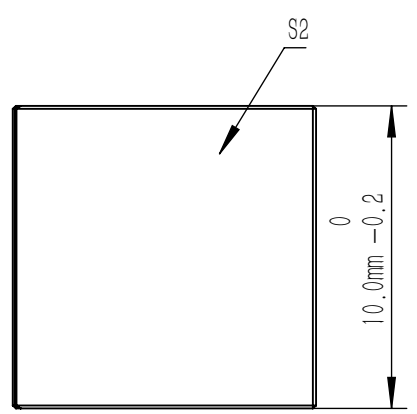

DRAWING PROJECTION			LBTEK			
	NAME	DATE				
DRAWN	LZHOU	Aug./12th/24	BEAM SPLITTER L=10.0 mm,R:T=50:50@1100 nm-1650 nm			
APPROVAL	WCHENG	Aug./12th/24	MATERIAL	WEIGHT	SCALE	REV
FOR INFORMATION ONLY NOT FOR MANUFACTURING PURPOSES			N-BK7	2.5 g	4:1	A