

	PART DESCRIPTION	MATERIAL
①	LENS MOUNT	6061-T6
②	ROUND CYLINDRICAL LENS	UVFS

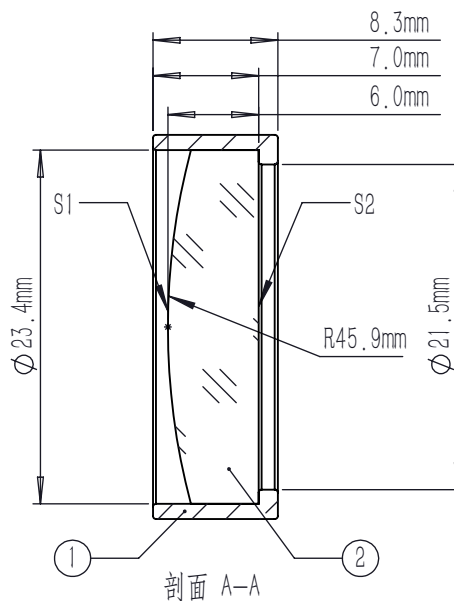
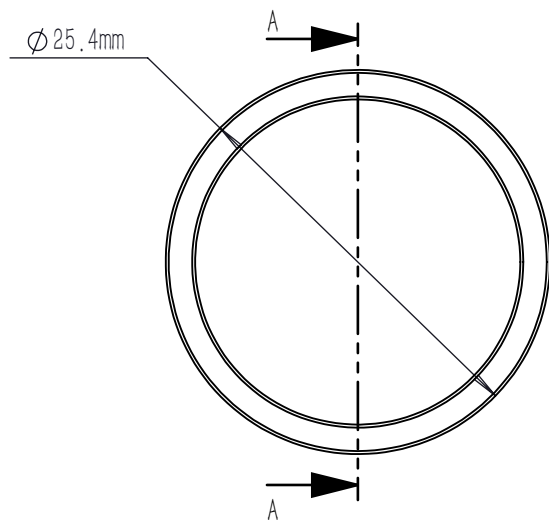

NOTES:

- DESIGN WAVELENGTH: 587.6 nm
- OPERATION WAVELENGTH: 245 nm-400 nm
- DIAMETER TOLERANCE: +0.0/-0.1 mm
- THICKNESS TOLERANCE: ±0.1 mm
- FOCAL LENGTH: $f=100.0 \text{ mm} \pm 1\%$
- BACK FOCAL LENGTH(REF): $bf=95.9 \text{ mm}$
- CLEAR APERTURE: >90%CA
- SURFACE QUALITY(S/D)(S1, S2): 40/20
- SURFACE FLATNESS(S2): $\lambda/2 @ 632.8 \text{ nm}$
- SURFACE POWER(S1): $3 \lambda/2 @ 632.8 \text{ nm}$
- SURFACE IRREGULARITY(S1): $\lambda/4 @ 632.8 \text{ nm}$
- CENTRATION: <3 arcmin
- CHAMFER: <0.2 mm, 45°
- AR COATING(S1, S2): $R_{avg} < 0.5\% @ 245 \text{ nm}-400 \text{ nm}$ (6° AOI, single)

DRAWING PROJECTION			LBTEK			
	NAME	DATE	CY207R-F100-UV			
DRAWN	SHAN	MAY./7th/25	PLANO CONVEX CYLINDRICAL LENS			
APPROVAL	WCHENG	MAY./7th/25	MATERIAL	WEIGHT	SCALE	REV
FOR INFORMATION ONLY NOT FOR MANUFACTURING PURPOSES			N/A	7.25g	2:1	A