

	PART DESCRIPTION	MATERIAL
①	LENS MOUNT	6061-T6
②	ROUND CYLINDRICAL LENS	UVFS

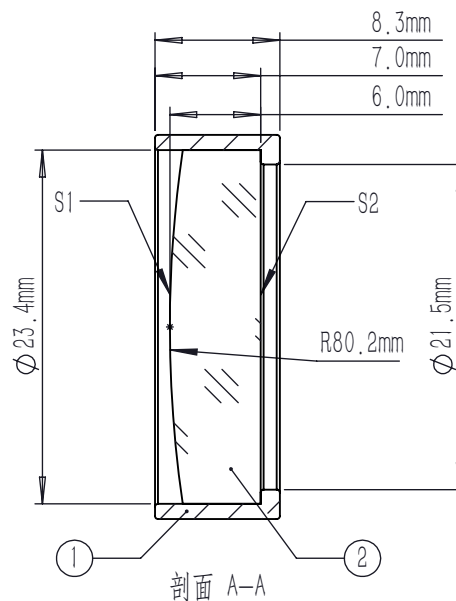
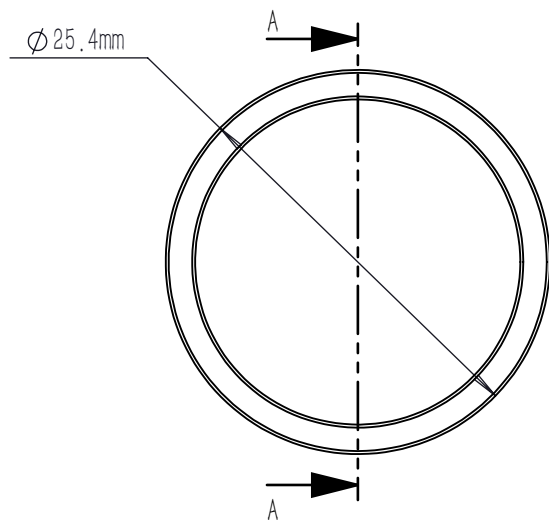

NOTES:

- DESIGN WAVELENGTH: 587.6 nm
- OPERATION WAVELENGTH: 245 nm-400 nm
- DIAMETER TOLERANCE: +0.0/-0.1 mm
- THICKNESS TOLERANCE: ±0.1 mm
- FOCAL LENGTH:  $f=175.0 \text{ mm} \pm 1\%$
- BACK FOCAL LENGTH(REF):  $bf=170.9 \text{ mm}$
- CLEAR APERTURE: >90%CA
- SURFACE QUALITY(S/D)(S1, S2): 40/20
- SURFACE FLATNESS(S2):  $\lambda/2 @ 632.8 \text{ nm}$
- SURFACE POWER(S1):  $3 \lambda/2 @ 632.8 \text{ nm}$
- SURFACE IRREGULARITY(S1):  $\lambda/4 @ 632.8 \text{ nm}$
- CENTRATION: <3 arcmin
- CHAMFER: <0.2 mm, 45°
- AR COATING(S1, S2):  $R_{avg} < 0.5\% @ 245 \text{ nm}-400 \text{ nm}$  (6° AOI, single)

DRAWING PROJECTION				<b>LBTEK</b>			
		NAME	DATE	CY207R-F175-UV			
DRAWN	SHAN	MAY./7th/25	PLANO CONVEX CYLINDRICAL LENS				
APPROVAL	WCHENG	MAY./7th/25	MATERIAL	WEIGHT	SCALE	REV	
FOR INFORMATION ONLY NOT FOR MANUFACTURING PURPOSES			N/A	7.40g	2:1	A	