

	PART DESCRIPTION	MATERIAL
①	LENS MOUNT	6061-T6
②	ROUND CYLINDRICAL LENS	UVFS

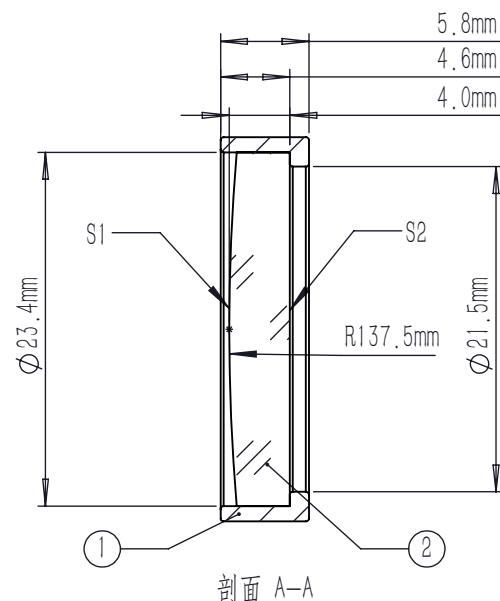
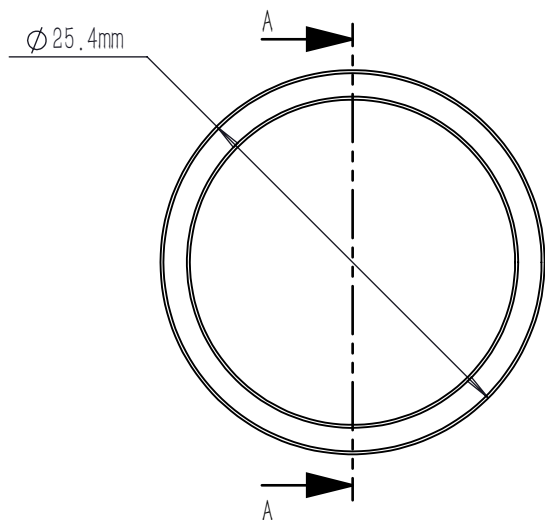

NOTES:

- DESIGN WAVELENGTH: 587.6 nm
- OPERATION WAVELENGTH: 350 nm-700 nm
- DIAMETER TOLERANCE: $+0.0/-0.1$ mm
- THICKNESS TOLERANCE: ± 0.1 mm
- FOCAL LENGTH: $f=300.0$ mm $\pm 1\%$
- BACK FOCAL LENGTH(REF): $bf=297.3$ mm
- CLEAR APERTURE: $>90\%$ CA
- SURFACE QUALITY(S/D)(S1, S2): 40/20
- SURFACE FLATNESS(S2): $\lambda/2$ @ 632.8 nm
- SURFACE POWER(S1): $3\lambda/2$ @ 632.8 nm
- SURFACE IRREGULARITY(S1): $\lambda/4$ @ 632.8 nm
- CENTRATION: <3 arcmin
- CHAMFER: <0.2 mm, 45°
- AR COATING(S1, S2): $R_{avg}<0.5\%$ @350 nm-700 nm (6° AOI, single)

DRAWING PROJECTION			LBTEK			
	NAME	DATE	CY207R-F300-A			
DRAWN	SHAN	MAY./7th/25	PLANO CONVEX CYLINDRICAL LENS			
APPROVAL	WCHENG	MAY./7th/25	MATERIAL	WEIGHT	SCALE	REV
FOR INFORMATION ONLY NOT FOR MANUFACTURING PURPOSES			N/A	5.09g	2:1	A