

	PART DESCRIPTION	MATERIAL
①	SM2-8A	ANODIZED ALUMINIUM
②	SM2R	ANODIZED ALUMINIUM
③	HWP51-780A	LCP/N-BK7

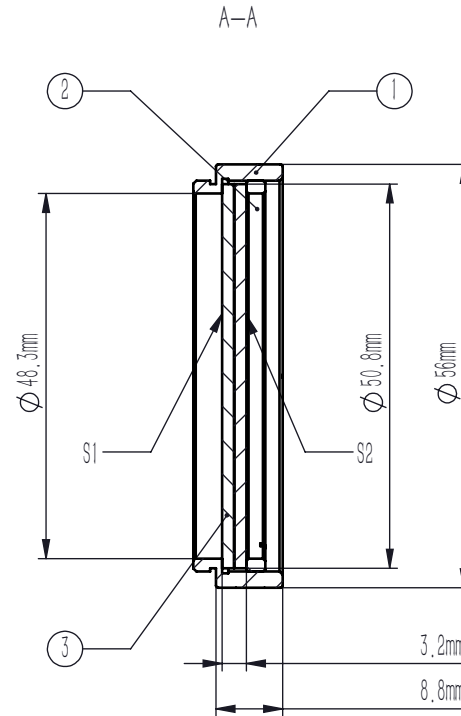

NOTES:

1. COMPONENT MATERIAL: LCP/N-BK7
2. ELEMENT DIAMETER: $\phi 50.8 +0/-0.1$ mm
3. ELEMENT THICKNESS: 3.2 ± 0.1 mm
4. OPTICAL APERTURE: $\phi 45$ mm
5. WORKING WAVELENGTH: 780 nm
6. RETARDANCE: $\lambda / 2$
7. SURFACE QUALITY (S/D): 60/40
8. AR COATING (S1, S2) : $R_{\text{avg}} < 0.7\%$
@700-1100 nm

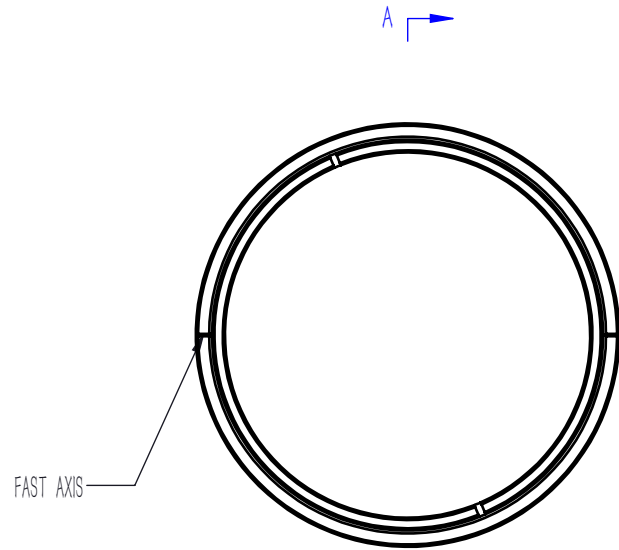

DRAWING PROJECTION			LBTEK			
	NAME	DATE	HWP51-780A-M			
DRAWN	SHAN	NOV./7th/24	Half Wave Plate			
APPROVAL	WCHENG	NOV./7th/24	MATERIAL	WEIGHT	SCALE	REV
FOR INFORMATION ONLY NOT FOR MANUFACTURING PURPOSES			N-BK7/LCP	29.05 g	1:1	A