

剖面 A-A

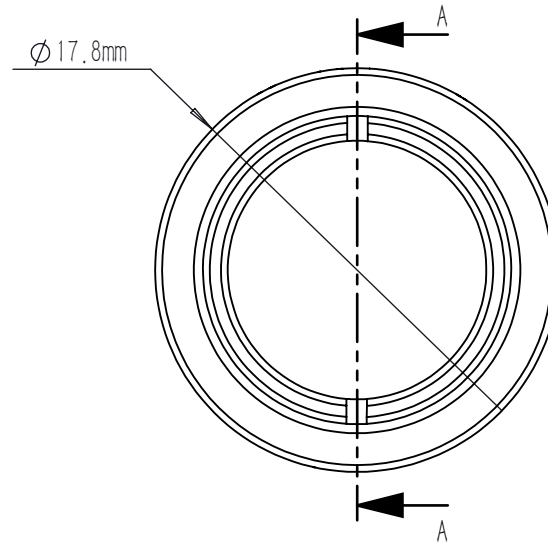

NOTES:

1. DESIGN WAVELENGTH: 488 nm, 707 nm&1064 nm
2. CLEAR APERTURE: >90 %CA
3. OPERATION WAVELENGTH: 400 nm-1100 nm
4. DIAMETER TOLERANCE: +0.0/-0.1 mm
5. THICKNESS TOLERANCE: ±0.1 mm
6. FOCAL LENGTH: 75.0 mm ± 1 % @ 707 nm
7. BACK FOCAL LENGTH: 72.7 mm
8. SURFACE QUALITY (S/D) (S1,S2) : 40/20
9. SURFACE POWER (S1,S2) : $3\lambda/2$ @ 632.8 nm
10. SURFACE IRREGULARITY (S1,S2) : $\lambda/4$ @ 632.8 nm
11. CENTRATION: <3 arcmin
12. CHAMFER: <0.2 mm, 45°
13. AR COATING (S1,S2) : $R_{avg} < 1\%$ @ 400 nm-1100 nm, 0° AOI

	PART DESCRIPTION	MATERIAL
①	SM05-8A	ANODIZED ALUMINIUM
②	AD312-AB	N-BK7
		N-SF2
③	SM05R	ANODIZED ALUMINIUM

DRAWING PROJECTION			LBTEK			
	NAME	DATE	MAD312-AB			
DRAWN	SHAN	JUL./26th/24	ACHROMATIC DOUBLETS			
APPROVAL	WCHENG	JUL./26th/24	MATERIAL	WEIGHT	SCALE	REV
FOR INFORMATION ONLY NOT FOR MANUFACTURING PURPOSES			N/A	3.96g	3:1	A