

**LBTEK**

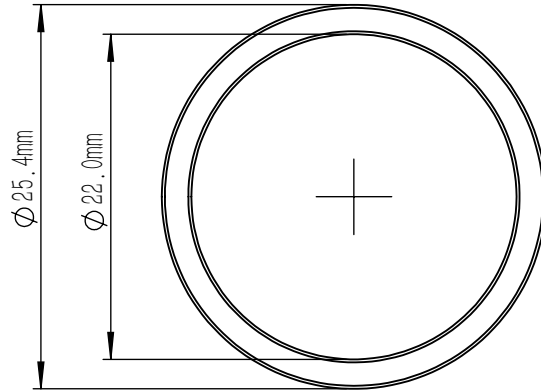

NOTES

1. MATERIAL: Schott Borofloat & Soda Lime
2. CWL: 660 nm  $\pm$  2 nm
3. FWHM: 10 nm  $\pm$  2 nm
4. TRANSMISSION: >50%
5. STOP BAND: >OD4@200-1100 nm
6. BEST OPERATING TEMPERATURE: 23°C
7. SNAP RING PROCESSING: BLACK ANODIZED
8. OPERATING TEMPERATURE: -50°C ~ +80°C
9. SURFACE QUALITY(S/D): 80/50

DRAWING PROJECTION			<b>LBTEK</b>			
	NAME	DATE	MBF10-660-10			
DRAWN	LZHOU	JUL./30th/24	LASER LINE FILTER CWL: 660 nm $\pm$ 2 nm, FWHM: 10 nm $\pm$ 2 nm			
APPROVAL	WCHENG	JUL./30th/24	MATERIAL	WEIGHT	SCALE	REV
FOR INFORMATION ONLY NOT FOR MANUFACTURING PURPOSES			Schott Borofloat & Soda Lime	7 g	2:1	B