

MBP12-561-10 ↓

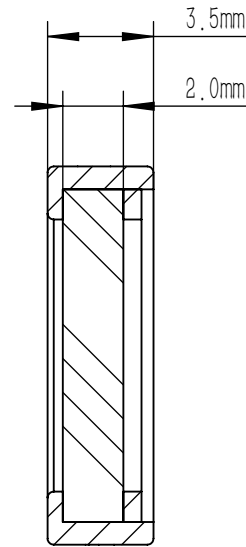

D-D  
4 : 1

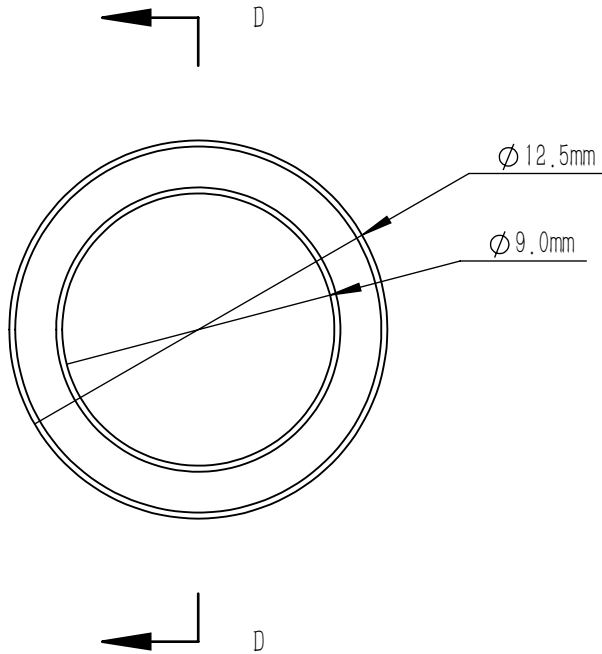

LBTEK

NOTES

1. MATERIAL: UVFS
2. CLEAR APERTURE:  $\phi 9.0$  mm
3. CENTER APERTURE:  $561 \text{ nm} \pm 2 \text{ nm}$
4. FWHM:  $10 \text{ nm} \pm 1.5 \text{ nm}$
5. SURFACE FLATNES:  $\text{RMS} \leq \lambda / 4 @ 633 \text{ nm}$
6. SURFACE QUALITY(S1, S2): 60/40(S/D)
7. COATING(S1): BANDPASS FILTER,  $0^\circ \text{ AOI}$   
 $\text{Tabs} > 90\% @ 561 \text{ nm};$   
 $\text{ODabs} > \text{OD5} @ 200 \text{ nm} - 1200 \text{ nm};$
8. OPERATING TEMPERATURE:  $-40^\circ \text{ C} \sim +90^\circ \text{ C}$

DRAWING PROJECTION			<b>LBTEK</b>			
	NAME	DATE	MBP12-561-10			
DRAWN	JLIU	OCT./21st/25	BANDPASS FILTER $\phi 12.5 \text{ mm}, \text{CWL}=561 \text{ nm}, \text{FWHM}=10 \text{ nm}$			
APPROVAL	WCHENG	OCT./21st/25	MATERIAL	WEIGHT	SCALE	REV
FOR INFORMATION ONLY NOT FOR MANUFACTURING PURPOSES			UVFS	0.77 g	4:1	A