

MBP25-650-50 ↓

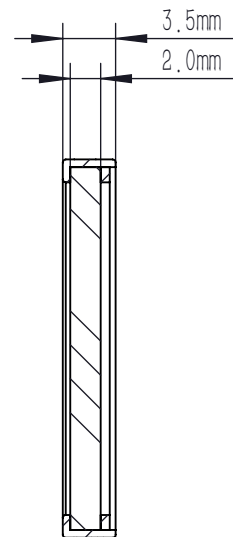

D-D

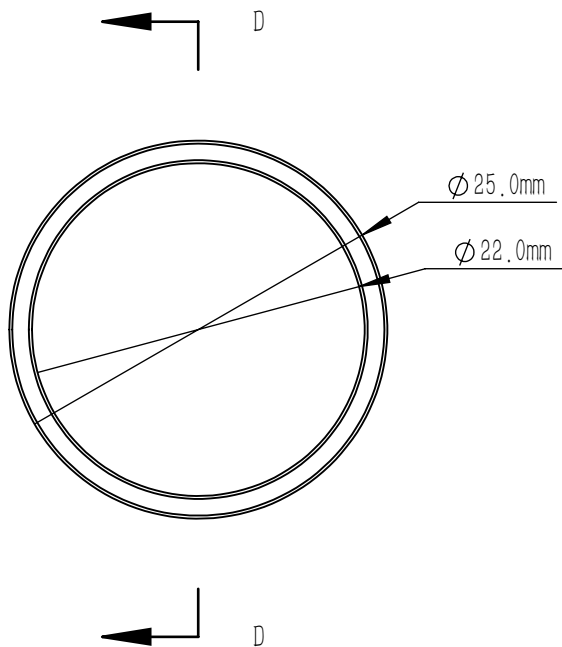
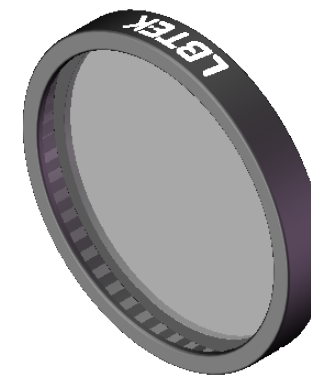

LBTEK

NOTES

1. MATERIAL: UVFS
2. CLEAR APERTURE: $\varnothing 22.0$ mm
3. CENTER APERTURE: $650 \text{ nm} \pm 4 \text{ nm}$
4. FWHM: $50 \text{ nm} \pm 2 \text{ nm}$
5. SURFACE FLATNES: $\text{RMS} \leq \lambda / 4 @ 633 \text{ nm}$
6. SURFACE QUALITY(S1, S2): 60/40(S/D)
7. COATING(S1): BANDPASS FILTER, 0° AOI
 Tabs $> 90\% @ 650 \text{ nm}$;
 ODabs $> OD5 @ 200 \text{ nm} - 1200 \text{ nm}$;
8. OPERATING TEMPERATURE: $-40^\circ \text{ C} \sim +90^\circ \text{ C}$

DRAWING PROJECTION			LBTEK			
	NAME	DATE				
DRAWN	JLIU	OCT./21st/25	BANDPASS FILTER $\varnothing 25 \text{ mm}$, CWL=650 nm, FWHM=50 nm			
APPROVAL	WCHENG	OCT./21st/25	MATERIAL	WEIGHT	SCALE	REV
FOR INFORMATION ONLY NOT FOR MANUFACTURING PURPOSES			UVFS	2.56 g	2:1	A