

FRONT VIEW

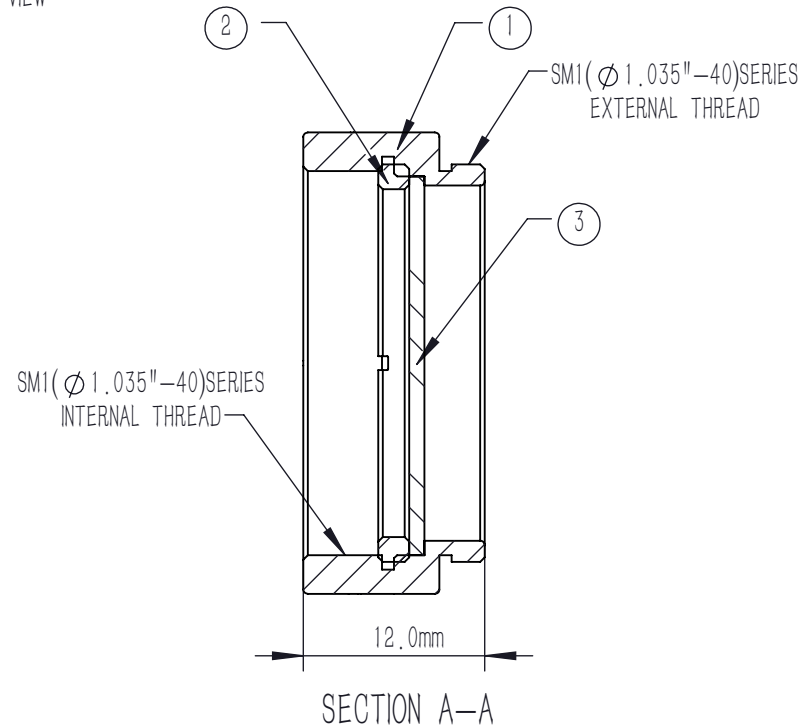

BACK VIEW



NUMBER	PART DESCRIPTION	MATERIAL
①	MECHANICAL HOUSING	BLACK ANODIZED ALUMINUM
②	SM1R	BLACK ANODIZED ALUMINUM
③	WAVEPLATE	QUARTZ

NOTES

- DESIGN WAVELENGTH: 1550 nm
- CLEAR APERTURE: >90% CA
- DELAY:  $m\lambda + \lambda/2$
- DELAY TOLERANCE:  $\pm \lambda/300$
- WAVEFRONT ERROR(RMS):  $\lambda/10$  @633 nm
- AR COATING(S1,S2): V coating @1550 nm  
 $R_{avg} < 0.25\%$  (6° AOI, SINGLE SURFACE)
- CHAMFER: 45° , <0.2 mm
- SURFACE QUALITY(S1,S2): 10/5(S/D)
- PARALLELISM(S1,S2): <3 arcsec

DRAWING PROJECTION				<b>LBTEK</b>			
	NAME	DATE	MHWP20-1550BM				
DRAWN	LZHOU	JUL./19th/24	QUARTZ MULTI-ORDER WAVEPLATE SM1 LENS TUBE, Ø 25.4 mm, λ/2@1550 nm				
APPROVAL	WCHENG	JUL./19th/24	MATERIAL	WEIGHT	SCALE	REV	
FOR INFORMATION ONLY NOT FOR MANUFACTURING PURPOSES			QUARTZ	8.3 g	2:1	B	