

FRONT VIEW

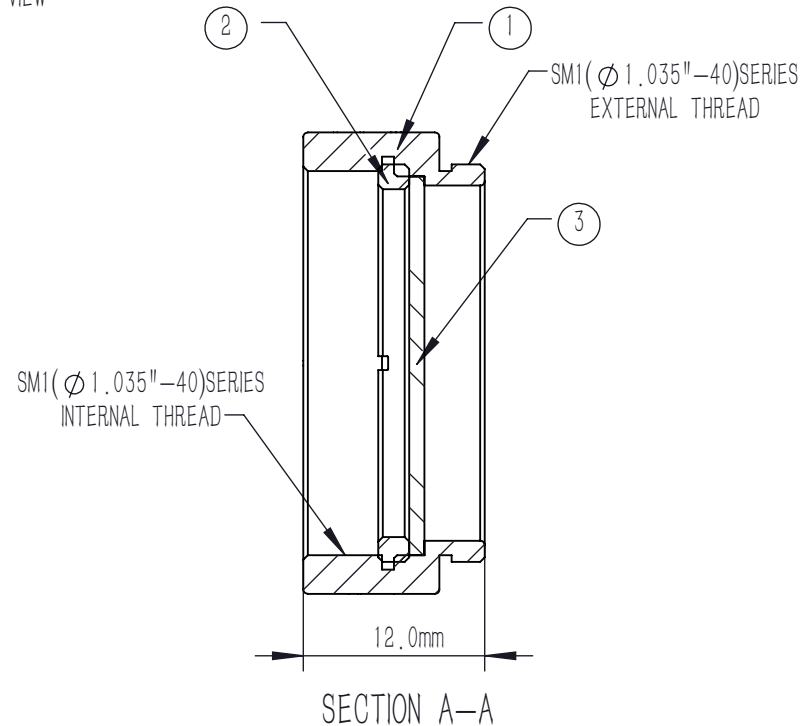

BACK VIEW

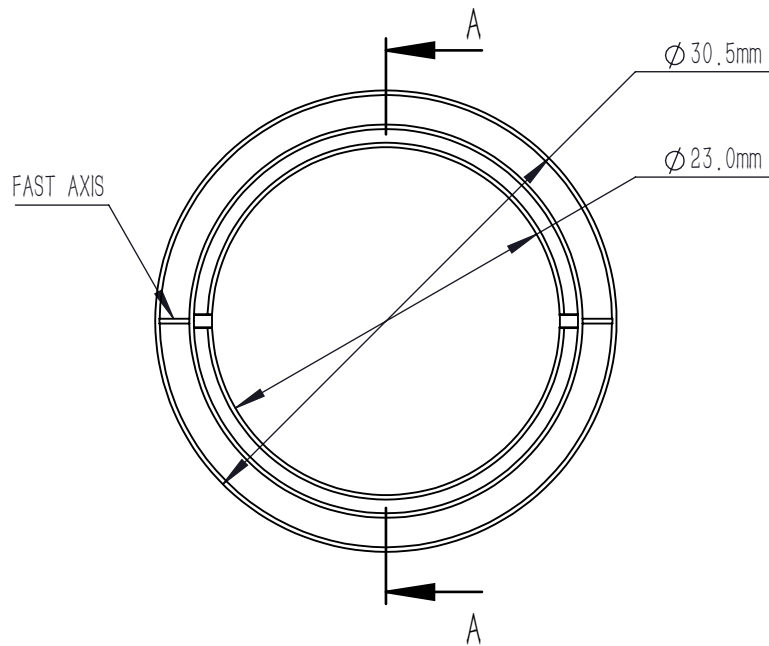

NUMBER	PART DESCRIPTION	MATERIAL
①	MECHANICAL HOUSING	BLACK ANODIZED ALUMINUM
②	SM1R	BLACK ANODIZED ALUMINUM
③	WAVEPLATE	QUARTZ

NOTES

1. DESIGN WAVELENGTH: 808 nm
2. CLEAR APERTURE: >90% CA
3. DELAY:  $m\lambda + \lambda/2$
4. DELAY TOLERANCE:  $\pm \lambda/300$
5. WAVEFRONT ERROR(RMS):  $\lambda/10$  @633 nm
6. AR COATING(S1,S2): V coating @808 nm  
 $R_{avg} < 0.25\%$  (6° AOI, SINGLE SURFACE)
7. CHAMFER: 45° , <0.2 mm
8. SURFACE QUALITY(S1,S2): 10/5(S/D)
9. PARALLELISM(S1,S2): <3 arcsec

DRAWING PROJECTION				<b>LBTEK</b>			
	NAME	DATE	MHWP20-808BM				
DRAWN	LZHOU	JUL./19th/24	QUARTZ MULTI-ORDER WAVEPLATE SM1 LENS TUBE, $\phi 25.4$ mm, $\lambda/2@808$ nm				
APPROVAL	WCHENG	JUL./19th/24	MATERIAL	WEIGHT	SCALE	REV	
FOR INFORMATION ONLY NOT FOR MANUFACTURING PURPOSES			QUARTZ	8.3 g	2:1	B	