

FRONT VIEW

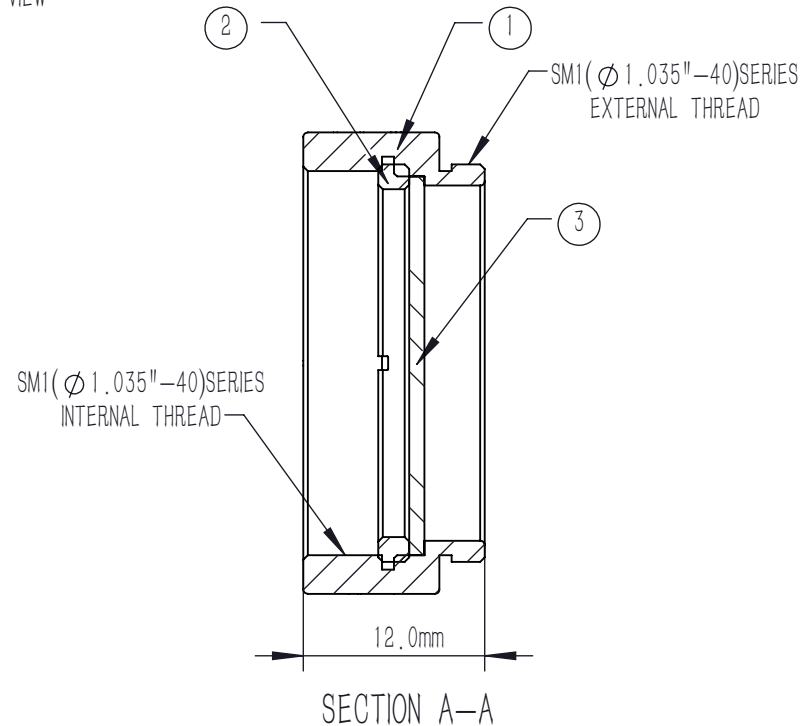

BACK VIEW

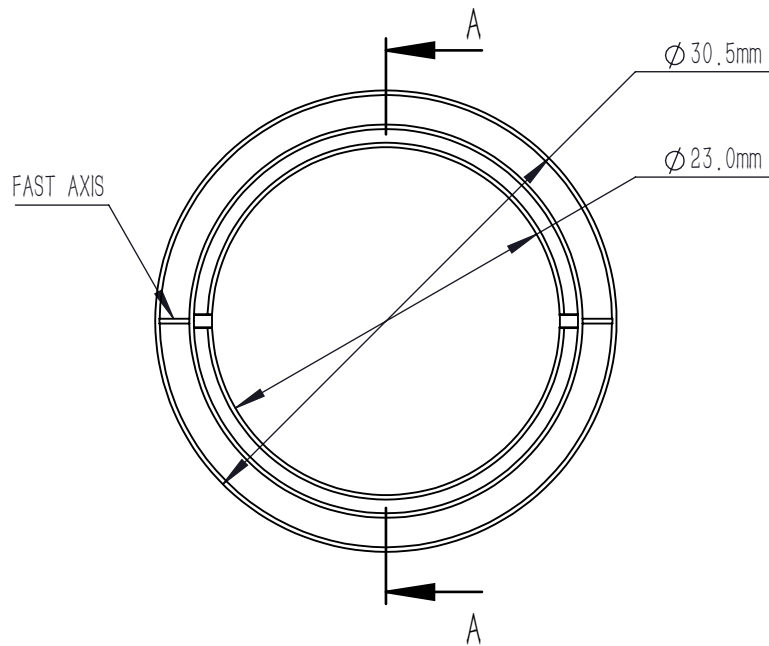

NUMBER	PART DESCRIPTION	MATERIAL
①	MECHANICAL HOUSING	BLACK ANODIZED ALUMINUM
②	SM1R	BLACK ANODIZED ALUMINUM
③	WAVEPLATE	QUARTZ

NOTES

1. DESIGN WAVELENGTH: 905 nm
2. CLEAR APERTURE: >90% CA
3. DELAY: $m\lambda + \lambda/2$
4. DELAY TOLERANCE: $\pm \lambda/300$
5. WAVEFRONT ERROR(RMS): $\lambda/10$ @633 nm
6. AR COATING(S1,S2): V coating @905 nm
 $R_{avg} < 0.25\%$ (6° AOI, SINGLE SURFACE)
7. CHAMFER: 45° , <0.2 mm
8. SURFACE QUALITY(S1,S2): 10/5(S/D)
9. PARALLELISM(S1,S2): <3 arcsec

DRAWING PROJECTION				LBTEK			
	NAME	DATE	MHWP20-905BM				
DRAWN	LZHOU	JUL./19th/24	QUARTZ MULTI-ORDER WAVEPLATE SM1 LENS TUBE, Ø 25.4 mm, λ/2@905 nm				
APPROVAL	WCHENG	JUL./19th/24	MATERIAL	WEIGHT	SCALE	REV	
FOR INFORMATION ONLY NOT FOR MANUFACTURING PURPOSES			QUARTZ	8.3 g	2:1	B	