

NUMBER	PART DESCRIPTION	MATERIAL
①	MECHANICAL HOUSING	BLACK ANODIZED ALUMINUM
②	SM05R	BLACK ANODIZED ALUMINUM
③	NDFA05-40-B	ND Filter Glass

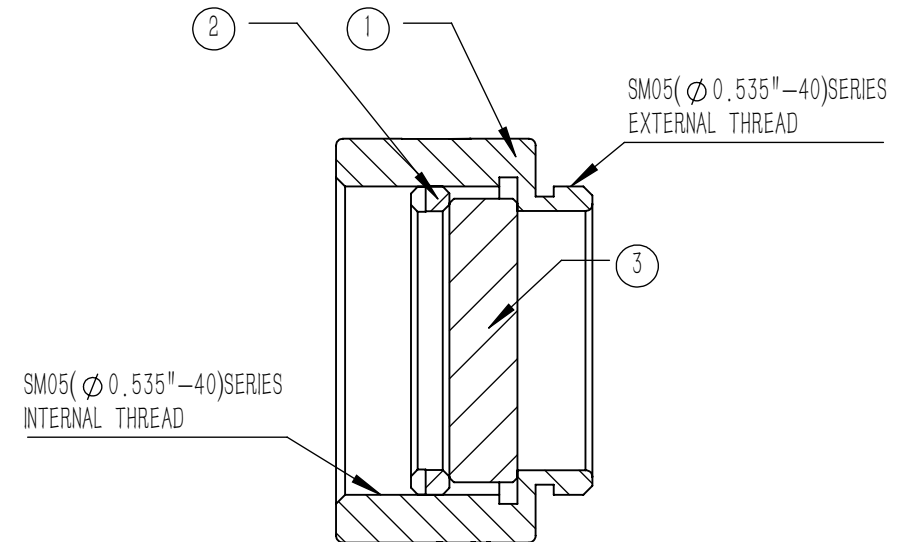

NOTES

- OPERATION WAVELENGTH: 700 nm-1100 nm
- OPTICAL DENSITY:  $4.0 \pm 5\%$ @850 nm
- CLEAR APERTURE: >90%CA
- SURFACE QUALITY(S1,S2): 40/20(S/D)
- SURFACE FLATNESS(S1,S2):  $\lambda/2$ @632.8 nm
- PARALLELISM(S1,S2): <10 arcsec
- CHAMFER: <0.2 mm, 45°
- COATING(S1): AR COATING,  $R_{avg} < 0.5\%$ @700 nm-1100 nm, 6° AOI
- OTHER SURFACES: FINE GROUND

DRAWING PROJECTION			<b>LBTEK</b>			
	NAME	DATE				
DRAWN	JLIU	NOV./26th/25	ABSORPTIVE NEUTRAL DENSITY FILTER SM05 LENS TUBE, OD=4.0, AR: 700 nm-1100 nm			
APPROVAL	WCHENG	NOV./26th/25	MATERIAL	WEIGHT	SCALE	REV
FOR INFORMATION ONLY NOT FOR MANUFACTURING PURPOSES			ND Filter Glass	3.84 g	2:1	A