

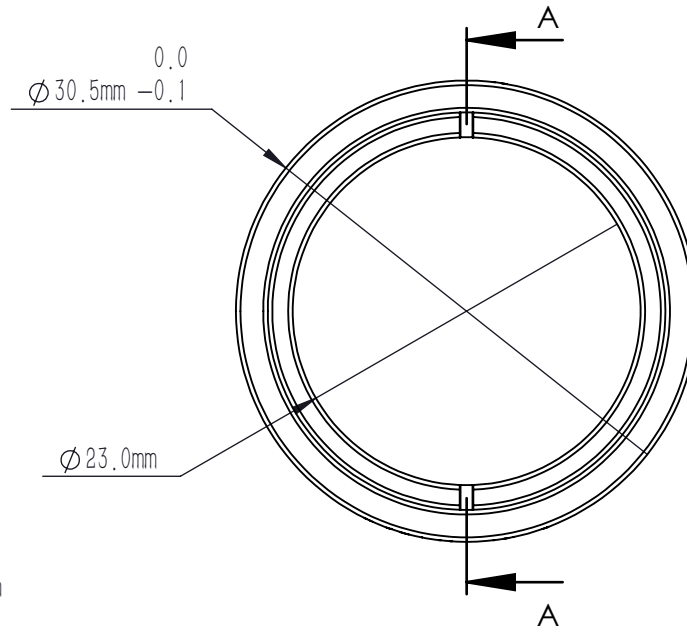

MNDFA10-02-C
 $\Phi 25.4 \text{ mm}, \text{OD}=0.2$
 AR:1100-1700 nm



NUMBER	PART DESCRIPTION	MATERIAL
①	MECHANICAL HOUSING	BLACK ANODIZED ALUMINUM
②	SM1R	BLACK ANODIZED ALUMINUM
③	NDA10-02-C	ND Filter Glass

NOTES

1. OPERATION WAVELENGTH: 1100 nm-1700 nm
2. OPTICAL DENSITY: $0.2 \pm 0.01 @ 1300 \text{ nm}$
3. CLEAR APERTURE: $>90\% \text{CA}$
4. DIAMETER TOLERANCE: $+0.00 / -0.25 \text{ mm}$
5. SURFACE QUALITY(S1, S2): 60/40(S/D)
6. SURFACE FLATNESS(S1, S2): $\lambda / 4 @ 632.8 \text{ nm}$
7. PARALLELISM(S1, S2): $<10 \text{ arcsec}$
8. CHAMFER: $<0.2 \text{ mm}, 45^\circ$
9. COATING(S1): AR COATING, $R_{\text{avg}} < 0.5\% @ 1100 \text{ nm}-1700 \text{ nm}, 6^\circ \text{ AOI}$
10. OTHER SURFACES: FINE GROUND

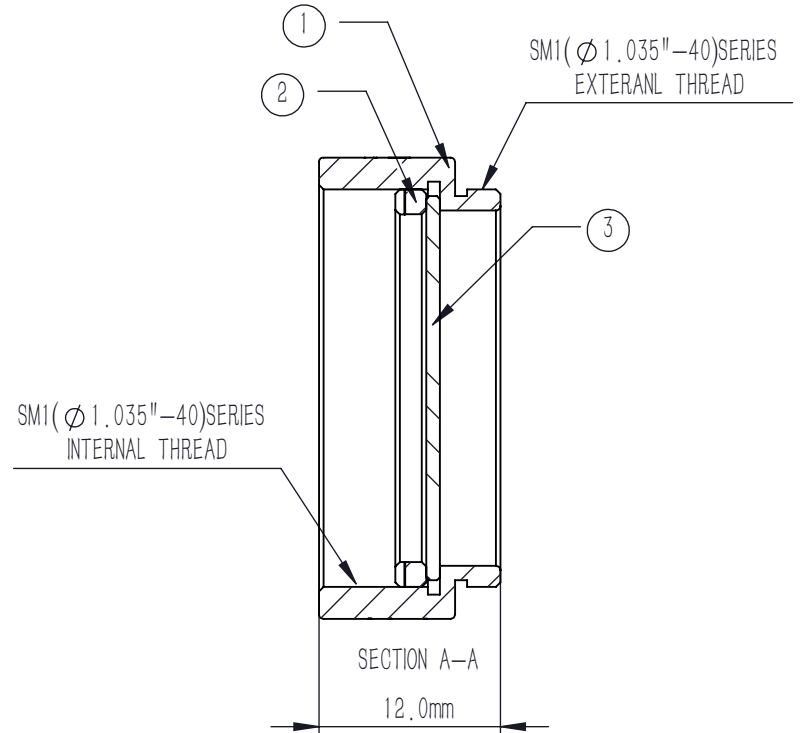

DRAWING PROJECTION			LBTEK			
	NAME	DATE	MNDFA10-02-C			
DRAWN	LZHOU	JUN./18th/24	ABSORPTIVE NEUTRAL DENSITY FILTER SM1 LENS TUBE, OD=0.2, AR: 1100 nm-1700 nm			
APPROVAL	WCHENG	JUN./18th/24	MATERIAL	WEIGHT	SCALE	REV
FOR INFORMATION ONLY NOT FOR MANUFACTURING PURPOSES			ND Filter Glass	7.6 g	2:1	B