

	PART DESCRIPTION	MATERIAL
①	SM1-8A	ANODIZED ALUMINIUM
②	NDFA10-05-NIR	ND FILTER GLASS
③	SM1R	ANODIZED ALUMINIUM

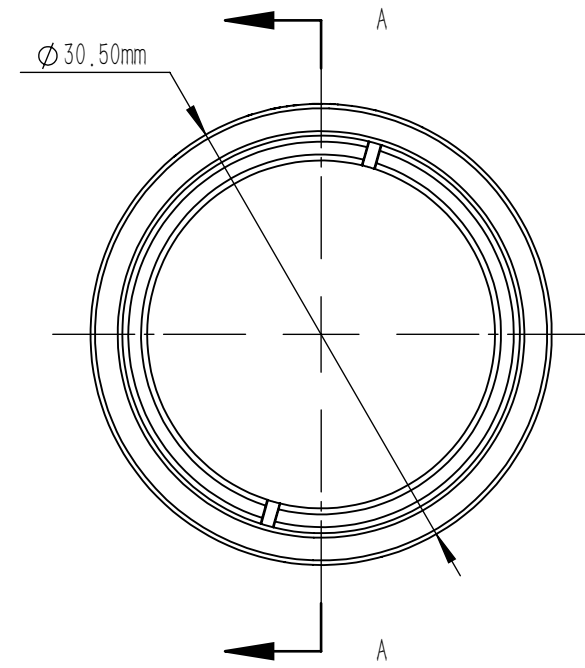
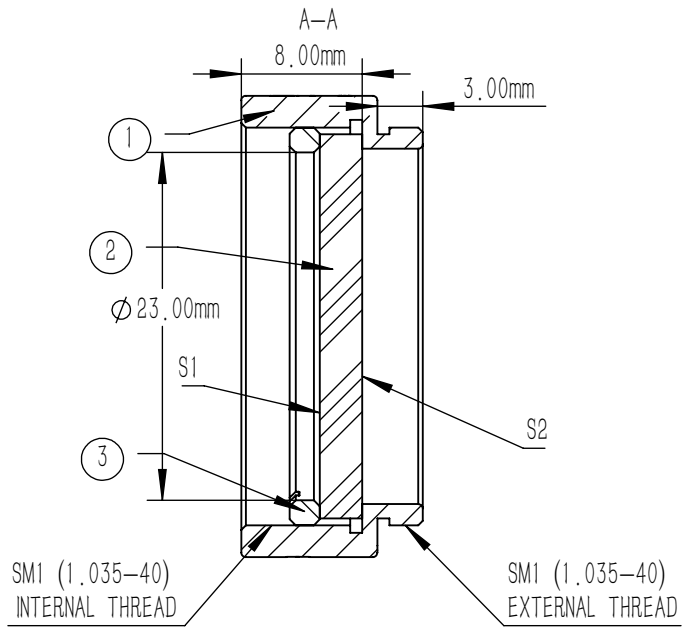

NOTES

- OPERATION WAVELENGTH: 1.0-2.6  $\mu\text{m}$
- OPTICAL DENSITY(OD):  $OD_{\text{abs}}=0.5 \pm 5\% @ 1550 \text{ nm}$   
 $OD_{\text{avg}}=0.5 \pm 5\% @ 1.0-2.6 \mu\text{m}$
- CLEAR APERTURE:  $>90\%CA$
- COATING(S1, S2): Uncoated
- SURFACE QUALITY(S1, S2): 40/20(S/D)
- SURFACE FLATNESS(S1, S2):  $PV < \lambda / 4 @ 632.8 \text{ nm}$
- PARALLELISM(S1, S2):  $< 10 \text{ arcsec}$
- OTHER SURFACES: FINE GROUND

DRAWING PROJECTION			<b>LBTEK</b>			
NAME	DATE	MNDFA10-05-NIR				
DRAWN	LTAN	2025/5/30	ABSORPTIVE ND FILTER $\phi 25.4 \text{ mm}, OD=0.5 @ 1.0 \mu\text{m}-2.6 \mu\text{m}$			
APPROVAL	WCHENG	2025/5/30	MATERIAL	WEIGHT	SCALE	REV
FOR INFORMATION ONLY NOT FOR MANUFACTURING PURPOSES			ND FILTER GLASS	9.7 g	2:1	A