

	PART DESCRIPTION	MATERIAL
①	SM2-8A	ANODIZED ALUMINIUM
②	NDAFA20-30-C	ND Filter Glass
③	SM2R	ANODIZED ALUMINIUM

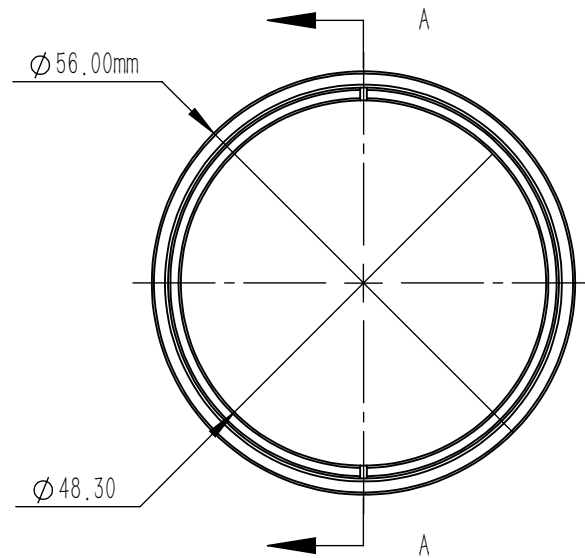
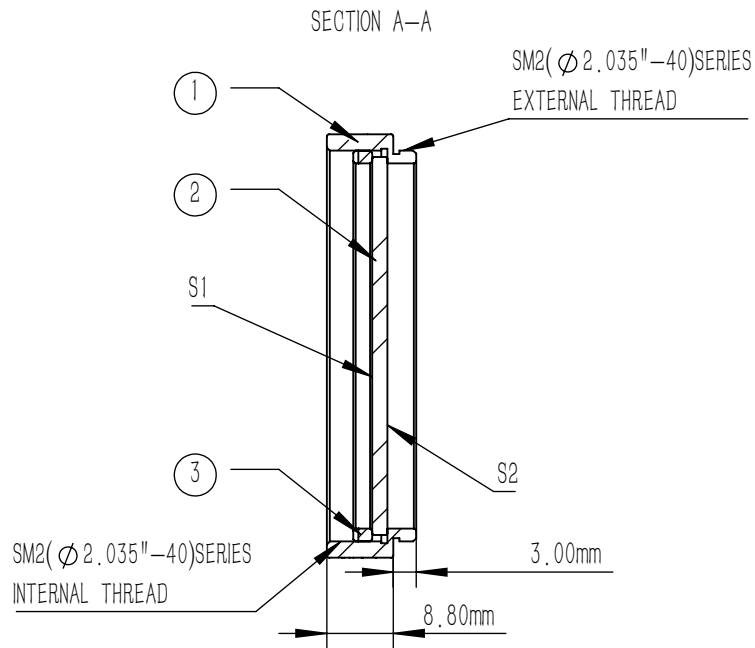

NOTES

1. OPERATION WAVELENGTH: 1100 nm-1700 nm
2. OPTICAL DENSITY: $3.0 \pm 5\%$ @1300 nm
3. CLEAR APERTURE: $>90\%$ CA
4. SURFACE QUALITY(S1,S2): 40/20(S/D)
5. SURFACE FLATNESS(S1,S2): λ @632.8 nm
6. PARALLELISM(S1,S2): <10 arcsec
7. CHAMFER: <0.2 mm, 45°
8. COATING(S1): AR COATING, $R_{avg} < 0.5\%$ @1100 nm-1700 nm, 6° AOI
9. OTHER SURFACES: FINE GROUND

DRAWING PROJECTION			LBTEK			
	NAME	DATE				
DRAWN	JLIU	NOV./25th/25	ABSORPTIVE NEUTRAL DENSITY FILTER SM2 LENS TUBE, OD=3.0, AR: 1100 nm-1700 nm			
APPROVAL	WCHENG	NOV./24th/25	MATERIAL	WEIGHT	SCALE	REV
FOR INFORMATION ONLY NOT FOR MANUFACTURING PURPOSES			ND Filter Glass	25.58 g	1:1	A