

NUMBER	PART DESCRIPTION	MATERIAL
①	SM05-8A	BLACK ANODIZED ALUMINUM
②	SM05R	BLACK ANODIZED ALUMINUM
③	NDFR05-03-IR	ZnSe

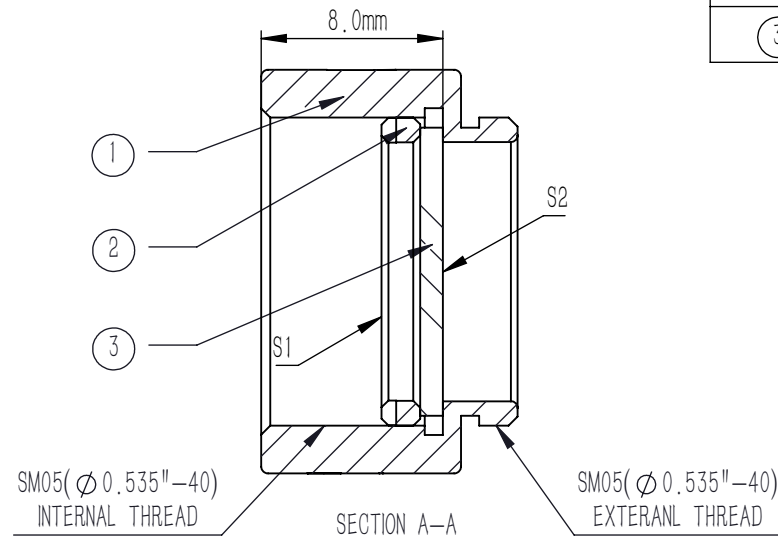
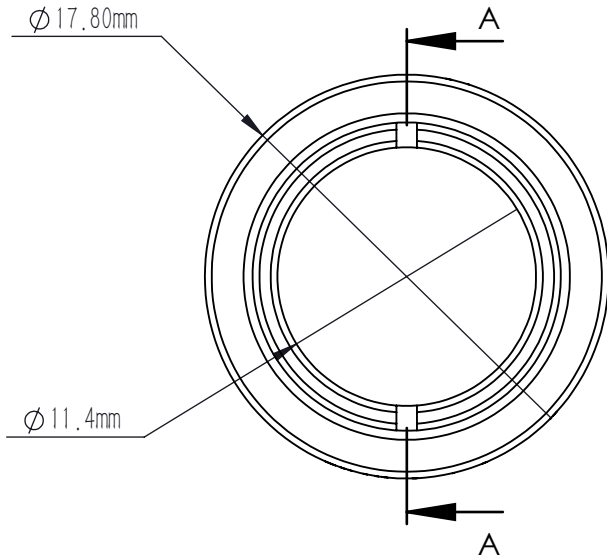

NOTES

- OPERATION WAVELENGTH: 2-16 μm
- OPTICAL DENSITY(OD): $OD_{\text{abs}}=0.3 \pm 5\% @ 5 \mu\text{m}$
 $OD_{\text{avg}}=0.3 \pm 5\% @ 2-16 \mu\text{m}$
- CLEAR APERTURE: $>90\%CA$
- COATING(S1): Ni
- SURFACE QUALITY(S1, S2): 60/40(S/D)
- SURFACE FLATNESS(S1): $PV < \lambda @ 632.8 \text{ nm}$
- PARALLELISM(S1, S2): $< 5 \text{ arcmin}$

DRAWING PROJECTION			LBTEK			
NAME	DATE	MNDFR05-03-IR				
DRAWN	LTAN	2025/1/6	REFLECTIVE ND FILTER SM05 LENS TUBE, $\phi 12.7 \text{ mm}$, $OD=0.3$			
APPROVAL	WCHENG	2025/1/6	MATERIAL	WEIGHT	SCALE	REV
FOR INFORMATION ONLY NOT FOR MANUFACTURING PURPOSES			ZnSe	3.60 g	3:1	A