

FRONT VIEW

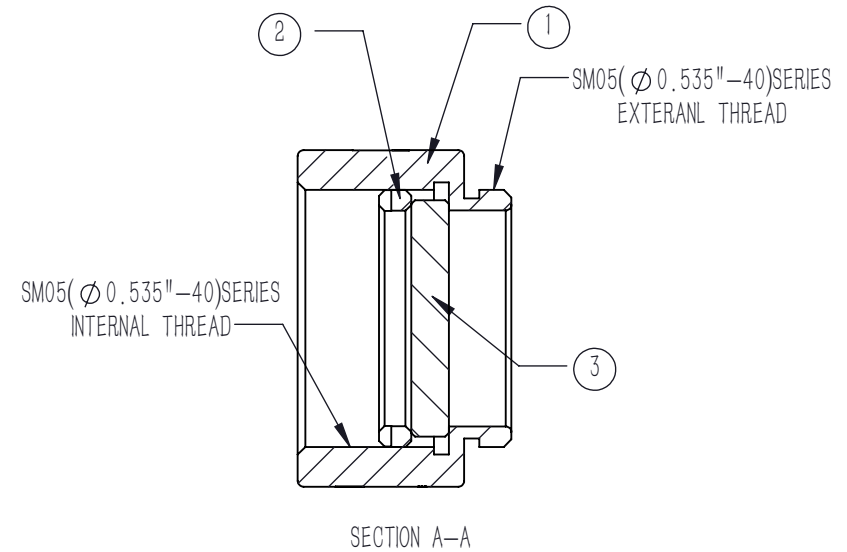

BACK VIEW

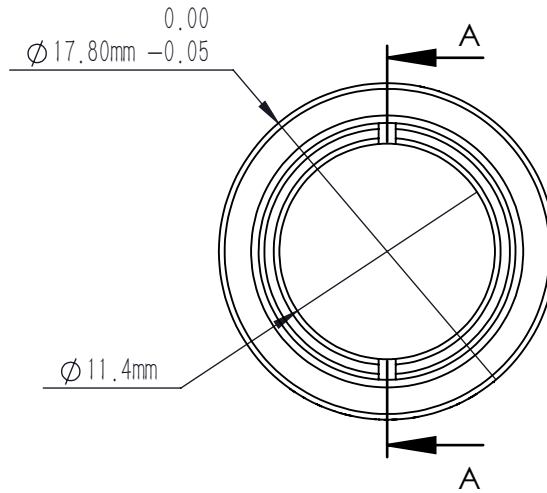



NUMBER	PART DESCRIPTION	MATERIAL
①	MECHANICAL HOUSING	BLACK ANODIZED ALUMINUM
②	SM05R	BLACK ANODIZED ALUMINUM
③	REFLECTIVE ND FILTER	N-BK7

NOTES

MNDFR05-02:

1. OPERATION WAVELENGTH: 350 nm-1100 nm
2. OPTICAL DENSITY(OD): 4.0±0.2@635 nm  
4.0±0.6@350 nm-1100 nm
3. CLEAR APERTURE: >90%CA
4. DIAMETER TOLERANCE: +0.00/-0.25 mm
5. THICKNESS TOLERANCE: ±0.3 mm
6. SURFACE QUALITY(S1,S2): 40/20(S/D)
7. SURFACE FLATNESS(S1,S2):  $\lambda/2@632.8$  nm
8. PARALLELISM(S1,S2): <30 arcsec
9. CHAMFER: <0.2 mm, 45°
10. COATING(S1): NiCrFe
11. OTHER SURFACES: FINE GROUND

DRAWING PROJECTION							
NAME	DATE	MNDFR05-40					
DRAWN	LZHOU	APR./2nd/24	REFLECTIVE ND FILTER SM05 LENS TUBE, Ø12.7 mm, OD=4.0				
APPROVAL	WCHENG	APR./2nd/24	MATERIAL	WEIGHT	SCALE	REV	
FOR INFORMATION ONLY NOT FOR MANUFACTURING PURPOSES			N-BK7	4.3 g	5:2	B	