

NUMBER	PART DESCRIPTION	MATERIAL
①	MECHANICAL HOUSING	BLACK ANODIZED ALUMINUM
②	PBS24-830-HP	UVFS

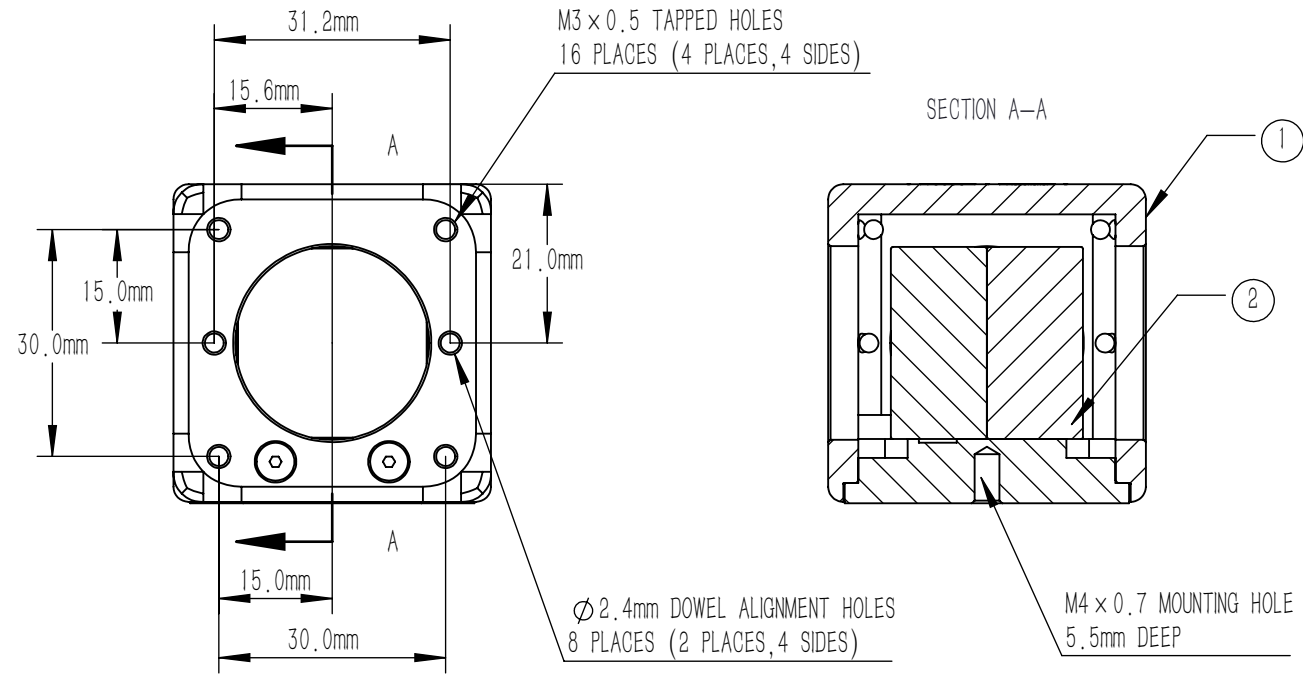

NOTES

PBS24-830-HP:

1. CLEAR APERTURE: >80% WxL
2. DIAMETER TOLERANCE: +0.0/-0.1 mm
3. EXTINCTION RATIO(Tp:Ts): >2000:1
4. DESIGN WAVELENGTH: 830 nm
5. TRANSMITTED BEAM DEVIATION: ≤5 arcmin
6. REFLECTED BEAM DEVIATION: ≤90° ±5 arcmin
7. SURFACE QUALITY(S/D): 20/10
8. WAVEFRONT ERROR(RMS): < λ/4@633 nm
9. PARALLELISM(S1,S2,S3,S4): ≤10 arcsec
10. AR COATING(S1,S2,S3,S4): V Coating @830 nm,Rabs: <0.25%,0° AOI
11. S POLARIZATION REFLECTION: >99.5%
12. P POLARIZATION TRANSMISSION: >97%
13. CHAMFER: <0.5 mm x 45°
14. OPERATING TEMPERATURE: -50° ~90°
15. GLUED(S5,S6): LIGHT GLUE PROCESS

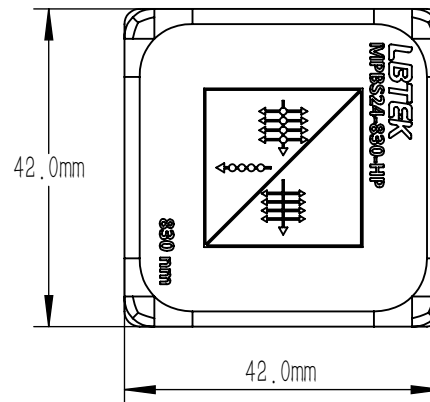

DRAWING PROJECTION			LBTEK			
	NAME	DATE	MPBS24-830-HP			
DRAWN	LZHOU	AUG./12th/24	LASER LINE POLARIZATION BEAM SPLITTE L=25.4 mm, Tp:Ts>2000:1@830 nm			
APPROVAL	WCHENG	AUG./12th/24	MATERIAL	WEIGHT	SCALE	REV
FOR INFORMATION ONLY NOT FOR MANUFACTURING PURPOSES			UVFS	117 g	1:1	C