

ACCEPTS $\phi 6.0\text{mm}$ [$\phi 0.24\text{in}$] POSTS

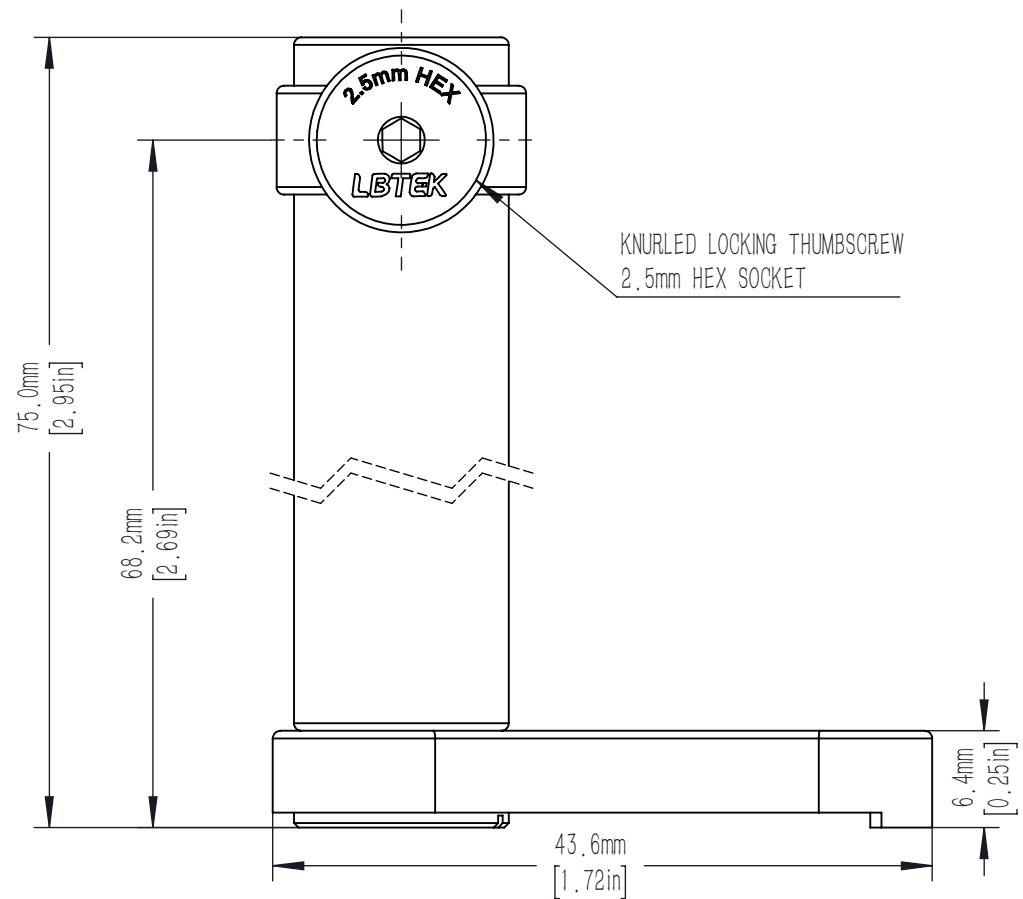
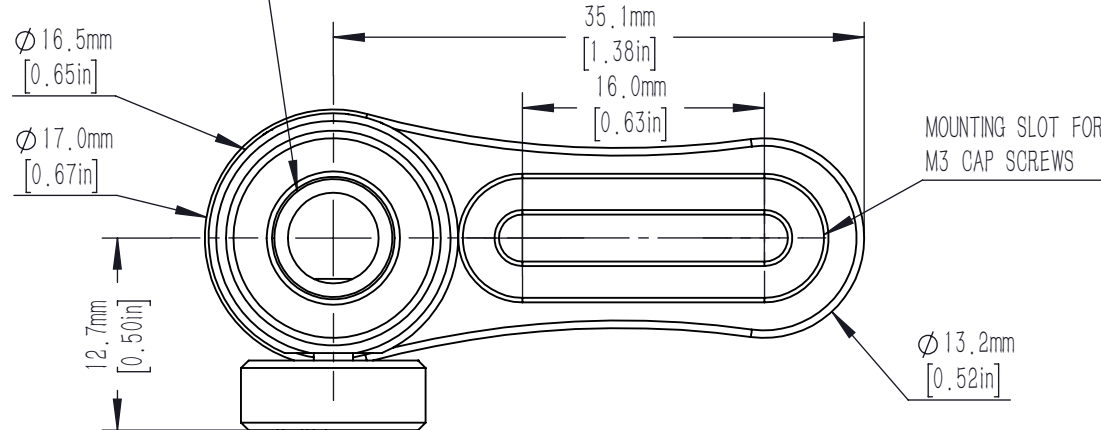

DRAWING PROJECTION			LBTEK			
NAME	DATE	MPH05-75B3				
DRAWN	ZLI	DEC./12th/23	$\phi 6\text{ mm}$ POST HOLDER			
APPROVAL	HDE	DEC./12th/23	MATERIAL	WEIGHT	SCALE	REV
FOR INFORMATION ONLY NOT FOR MANUFACTURING PURPOSES			N/A	0.035 Kg	2:1	B