

FRONT VIEW

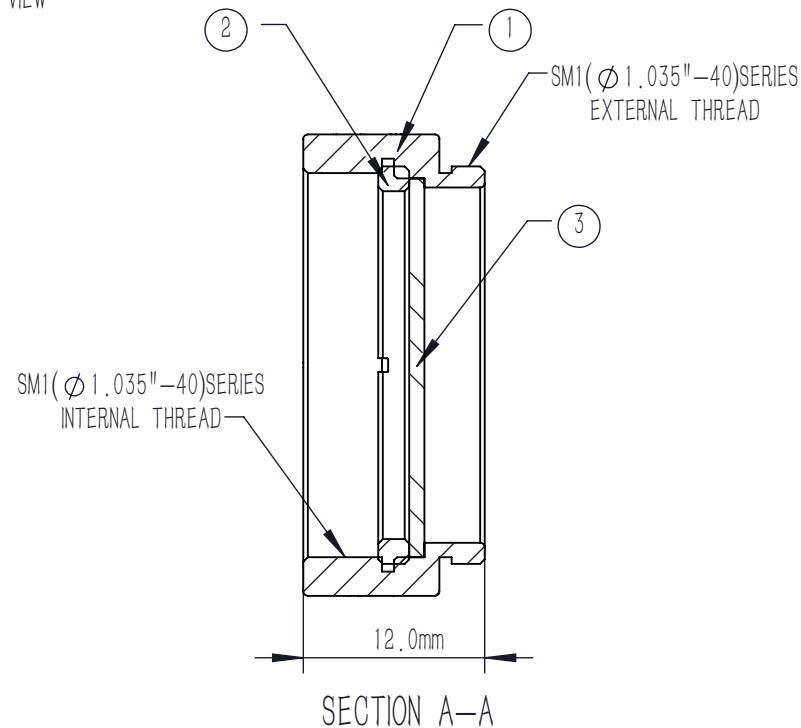

BACK VIEW



NUMBER	PART DESCRIPTION	MATERIAL
①	MECHANICAL HOUSING	BLACK ANODIZED ALUMINUM
②	SM1R	BLACK ANODIZED ALUMINUM
③	WAVEPLATE	QUARTZ

NOTES

- DESIGN WAVELENGTH: 532 nm
- CLEAR APERTURE: >90% CA
- DELAY: $m\lambda + \lambda/4$
- DELAY TOLERANCE: $\pm \lambda/300$
- WAVEFRONT ERROR(RMS): $\lambda/10$ @633 nm
- AR COATING(S1,S2): V coating @532 nm
 $R_{avg} < 0.25\%$ (6° AOI, SINGLE SURFACE)
- CHAMFER: 45°, <0.2 mm
- SURFACE QUALITY(S1,S2): 10/5(S/D)
- PARALLELISM(S1,S2): <3 arcsec

DRAWING PROJECTION							
	NAME	DATE	MQWP20-532BM				
DRAWN	LZHOU	JUL./23th/24	QUARTZ MULTI-ORDER WAVEPLATE SM1 LENS TUBE, $\phi 25.4$ mm, $\lambda/4@532$ nm				
APPROVAL	WCHENG	JUL./23th/24	MATERIAL	WEIGHT	SCALE	REV	
FOR INFORMATION ONLY NOT FOR MANUFACTURING PURPOSES			QUARTZ	8.3 g	2:1	B	