

FOR INFORMATION ONLY
NOT FOR MANUFACTURING PURPOSES

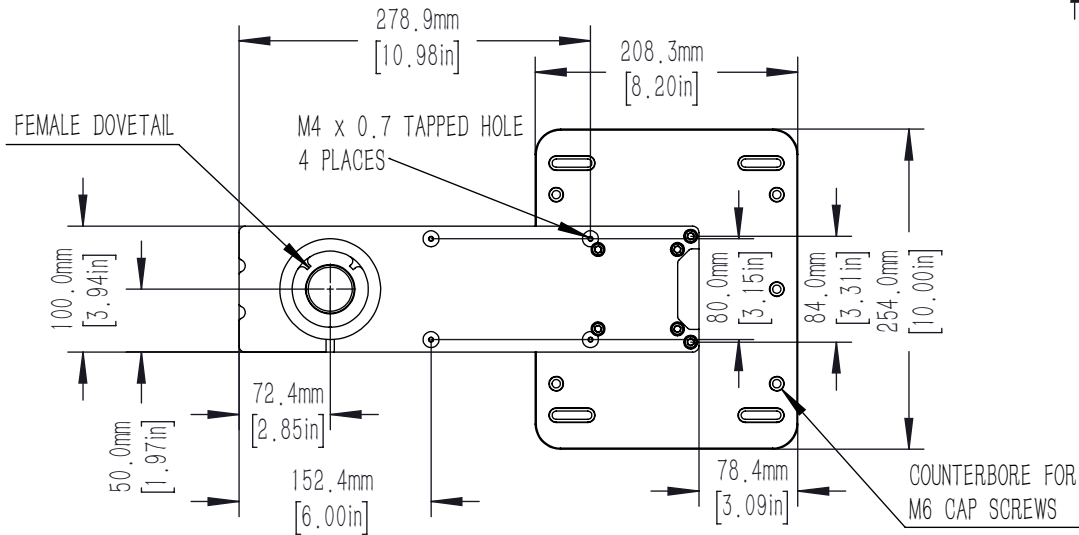
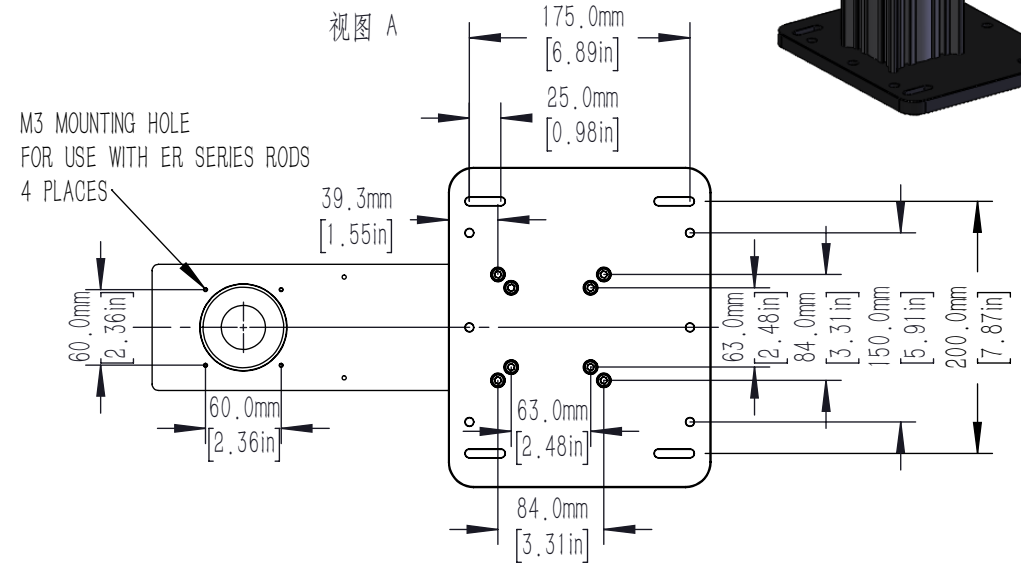
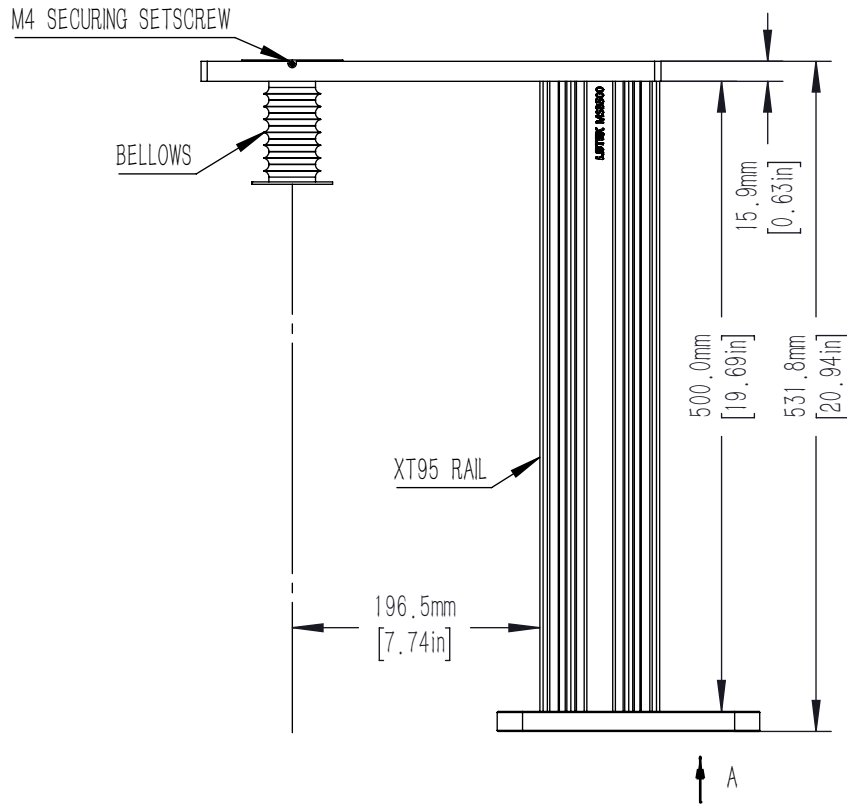

DRAWING PROJECTION				<h1 style="color: red; margin: 0;">LBTEK</h1>			
	NAME	DATE	MSB500				
DRAWN	PCHEN	AUG./9th/25	500 mm TALL BODY WITH EPI ARM				
APPROVAL	YHLI	AUG./9th/25	MATERIAL	WEIGHT	SCALE	REV	
FOR INFORMATION ONLY NOT FOR MANUFACTURING PURPOSES			N/A	7.762 Kg	1:6	A	