

VIEW SCALE 1:1

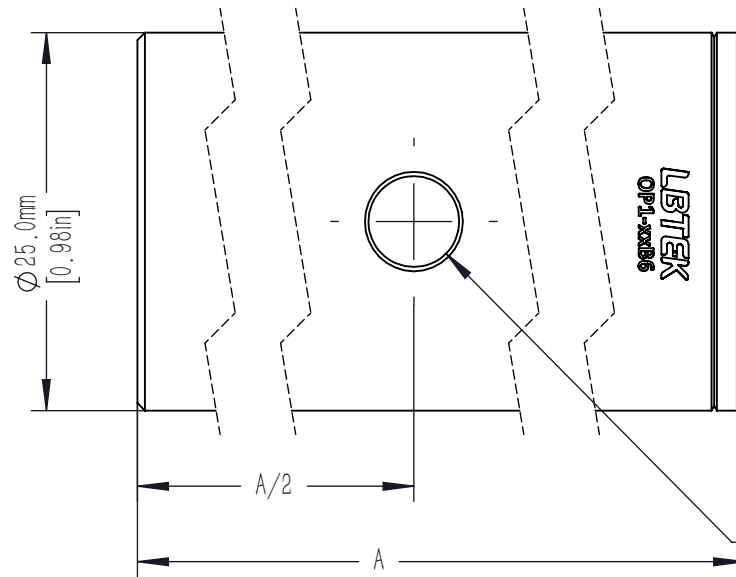

M6x1.0 MOUNTING HOLE
10mm [0.39in] DEEP

$\varnothing 14.5\text{mm}$ [0.57in]
 0.3mm[0.01in] DEEP

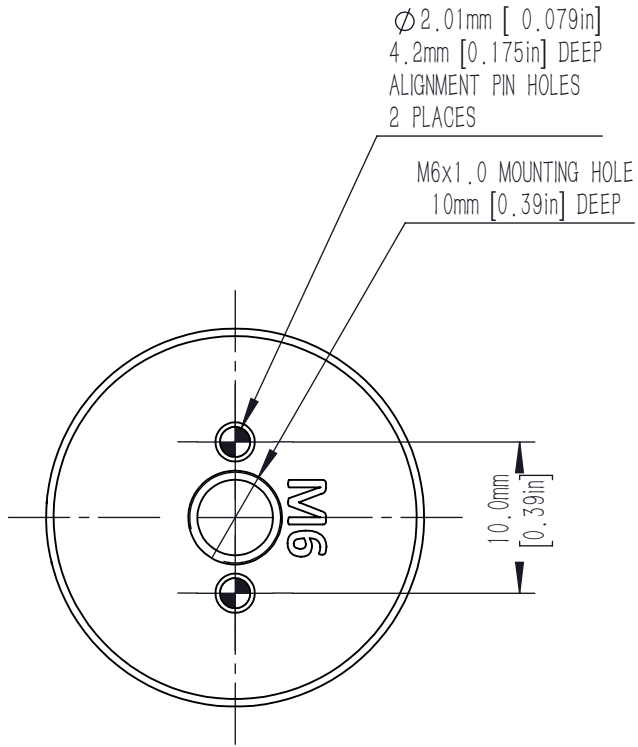
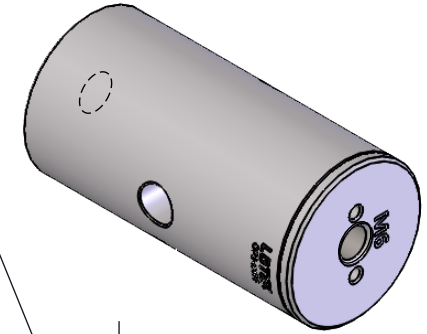
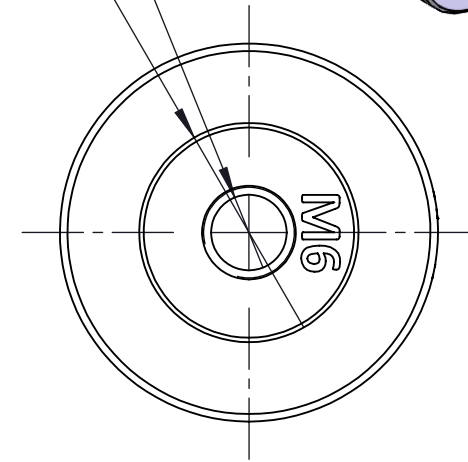

NO.	ITEM	A LENGTH/mm[in]	WEIGHT/kg
1	OP1-25B6	25[0.98]	0.09
2	OP1-38B6	38[1.50]	0.14
3	OP1-50B6	50[1.97]	0.19
4	OP1-75B6	75[2.95]	0.29
5	OP1-100B6	100[3.94]	0.39
6	OP1-200B6	200[7.87]	0.79
7	OP1-300B6	300[11.81]	1.19

DRAWING PROJECTION			LBTEK			
NAME	DATE					
			OP1-xxB6			
DRAWN	ZHE	NOV./18th/19	$\varnothing 25\text{mm}$ EXTENSION ROD			
APPROVAL	ZYANG	NOV./18th/19	MATERIAL	WEIGHT	SCALE	REV
FOR INFORMATION ONLY NOT FOR MANUFACTURING PURPOSES			STAINLESS STEEL	* Kg	2:1	B