

PARFOCAL DISTANCE	45 mm
WORKING DISTANCE	0.2 mm

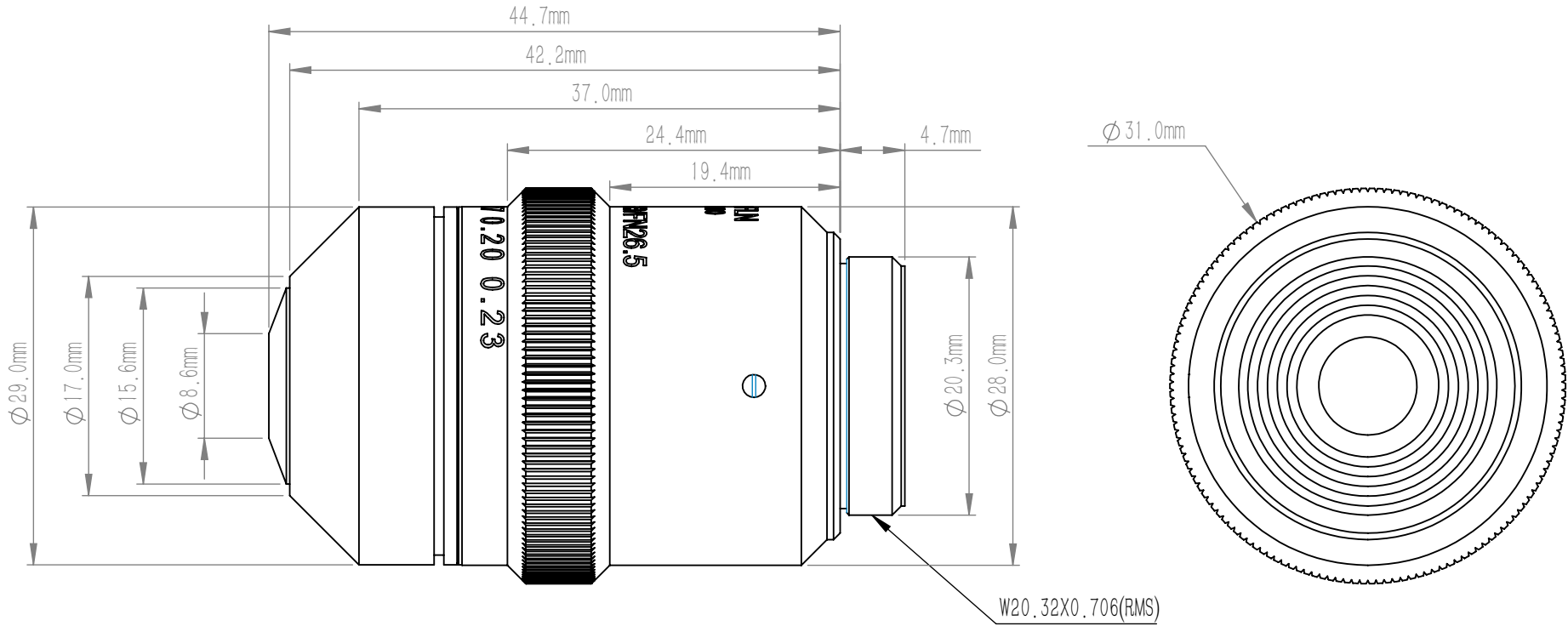

DRAWING PROJECTION			LBTEK www.lbtek.com			
	NAME	DATE	OPLNFL60X			
DRAWN	JLIU	2021/5/26	PLAN SEMI-ACHROMATIC OBJECTIVE			
APPROVAL	YFAN	2021/5/26	MATERIAL	WEIGHT	SCALE	REV
FOR INFORMATION ONLY NOT FOR MANUFACTURING PURPOSES			N/A	26.94 g	2:1	AE