

NOTES

1. MATERIAL: UVFS
2. CLEAR APERTURE: >90%
3. DESIGN WAVELENGTH: 405 nm
4. DIAMETER TOLERANCE: +0.0/-0.1 mm
5. THICKNESS TOLERANCE: ±0.1 mm
6. EXTINCTION RATIO: >10000: 1
7. SURFACE QUALITY(S/D): 40/20
8. WAVEFRONT ERROR(RMS): $\lambda/2@632.8$ nm
9. SPLITTING COATING(S1,S2): POLARIZATION SPLITTING COATING
 P POLARIZATION TRANSMISSION: $T_p > 93\% @ 405$ nm,
 S POLARIZATION TRANSMISSION: $T_s < 0.5\% @ 405$ nm; AOI 45°
10. CHAMFER: 45° , <0.3 mm

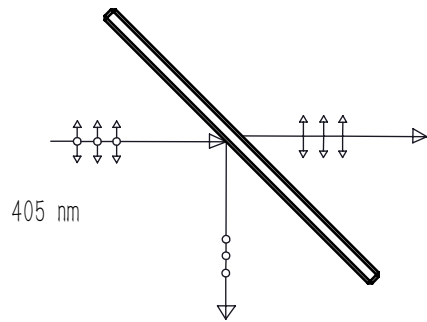

DRAWING PROJECTION			LBTEK			
NAME	DATE					
			PBSFR-24-405			
DRAWN	LZHOU	Aug./12th/24	POLARIZATION FLAT BEAM SPLITTER L x W x H=36.0 mm x 25.0 mm x 1.0 mm, 405 nm			
APPROVAL	WCHENG	Aug./12th/24	MATERIAL	WEIGHT	SCALE	REV
FOR INFORMATION ONLY NOT FOR MANUFACTURING PURPOSES			UVFS	2.0 g	2:1	B