

Self fixing mechanism slightly press from both sides for plugging and unplugging

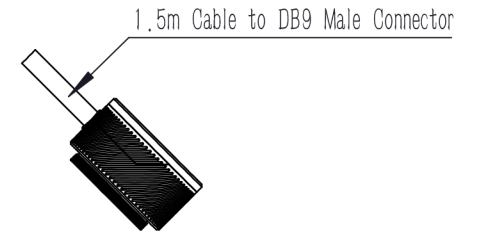
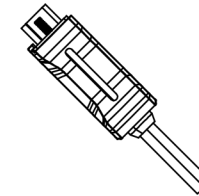
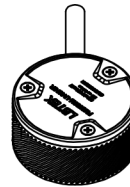
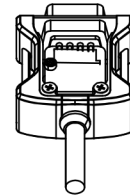
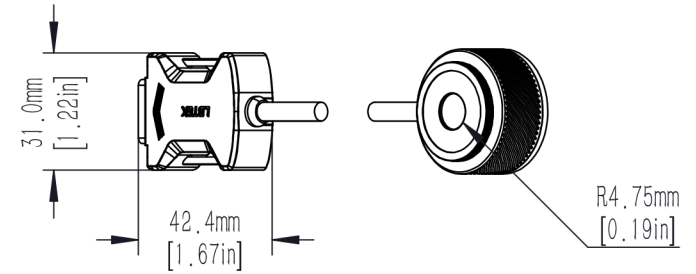
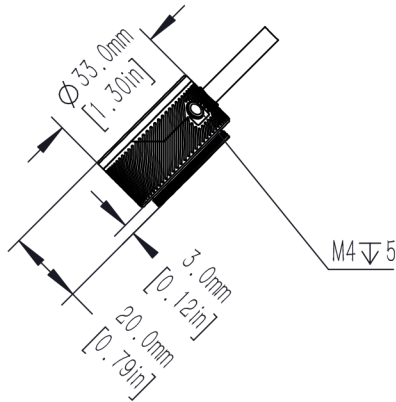
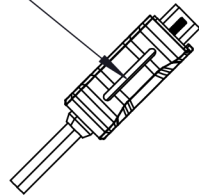

Connector Pin Diagram

N.C.
NTC
NTC GND
COM1
COM2
COM GND
N.C.
COM3
COM4

DRAWING PROJECTION							
	NAME	DATE	PMS500M—UVISNIR				
DRAWN	YYang	Oct./29th/25	Optical Power Meter Standard Sensor				
APPROVAL	JHWu	Oct./29th/25	MATERIAL	WEIGHT	SCALE	REV	
FOR INFORMATION ONLY NOT FOR MANUFACTURING PURPOSES			N/A	0.055 Kg	1.2	A	