

Pin screw for additional locking of the fiber ferrule.

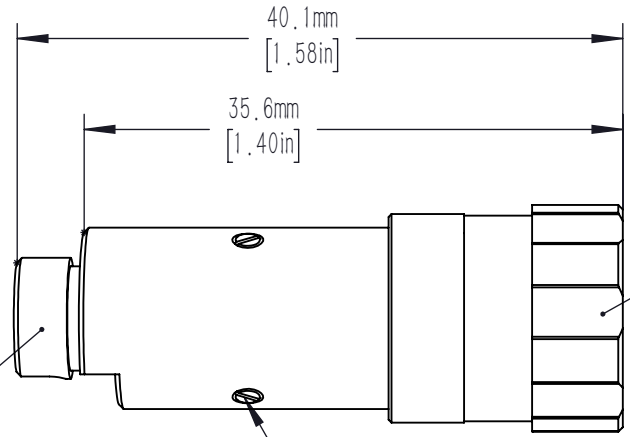
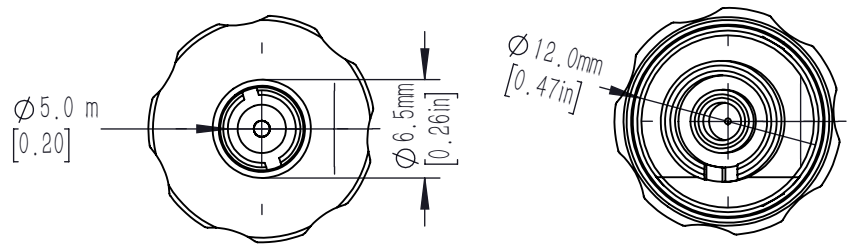

adjustment of focus setting

FC/APC wide key

clamp screws for locking optics position (2x120°)

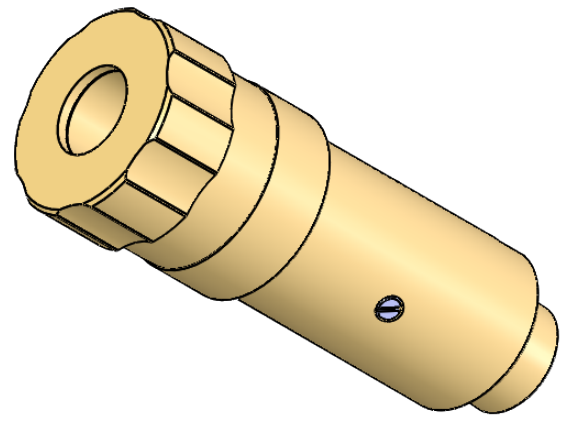

- notes,
- 1.focal length: 7.5 mm
 - 2.Waist beam spot diameter: 1.36 mm@ 515 nm 460HP
 - 3.Interface type: FC/APC
 - 4.Lens type: Aspheric lens
 - 5.Collimation divergence angle: $\leq 0.035^\circ$
 - 6.Lens coating: $R_{avg} \leq 0.5\% @ 350 - 700 \text{ nm}$

DRAWING PROJECTION			LBTEK			
	NAME	DATE				
DRAWN	BSHU	2026/2/9	FIBER COLLIMATOR			
APPROVAL	WCHENG	2026/2/9	MATERIAL	WEIGHT	SCALE	REV
FOR INFORMATION ONLY NOT FOR MANUFACTURING PURPOSES			Silicon brass	29 g	2:1	A