

NUMBER	PART DESCRIPTION	MATERIAL
①	WAVEPLATE	QUARTZ
②	GASKET	GASKET
③	O-RING	NITRILE
④	SM05R	BLACK ANODIZED ALUMINUM
⑤	MECHANICAL HOUSING	BLACK ANODIZED ALUMINUM

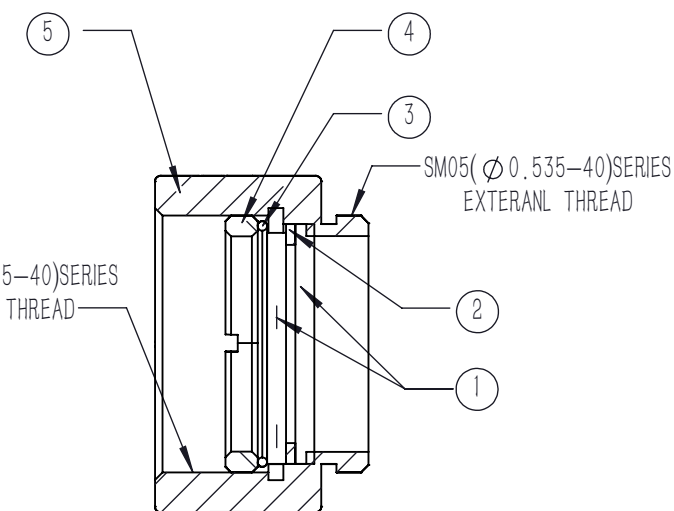

NOTES

- DESIGN WAVELENGTH: 1064 nm
- CLEAR APERTURE:  $\varnothing 10$  mm
- DELAY:  $\lambda/4$
- DELAY TOLERANCE:  $\pm \lambda/300$
- WAVEFRONT ERROR(RMS):  $\lambda/8$  @632.8 nm
- AR COATING: V coating @1064 nm,  
(S1,S2,S3,S4):  $R_{avg} < 0.25\%$  (6° AOI, SINGLE SURFACE)
- CHAMFER: 45° ,  $< 0.2$ mm
- SURFACE QUALITY(S1,S2,S3,S4): 20/10(S/D)
- PARALLELISM(S1,S2,S3,S4):  $< 10$  arcsec

DRAWING PROJECTION				<b>LBTEK</b>			
	NAME	DATE	QWPSM05-1064B				
DRAWN	LZHOU	JUL./15th/24	QUARTZ ZERO-ORDER WAVEPLATE SM05, $\varnothing 10$ mm CA, $\lambda/4$ , @1064 nm				
APPROVAL	WCHENG	JUL./15th/24	MATERIAL	WEIGHT	SCALE	REV	
FOR INFORMATION ONLY NOT FOR MANUFACTURING PURPOSES			QUARTZ	3.7 g	5:2	B	