

NUMBER	PART DESCRIPTION	MATERIAL
①	WAVEPLATE	QUARTZ
②	GASKET	GASKET
③	O-RING	NITRILE
④	SM05R	BLACK ANODIZED ALUMINUM
⑤	MECHANICAL HOUSING	BLACK ANODIZED ALUMINUM

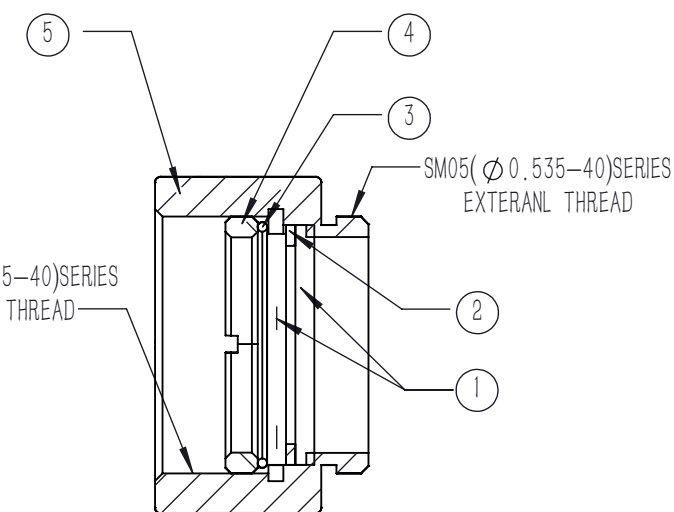

NOTES

1. DESIGN WAVELENGTH: 405 nm
2. CLEAR APERTURE: $\varnothing 10$ mm
3. DELAY: $\lambda/4$
4. DELAY TOLERANCE: $\pm \lambda/300$
5. WAVEFRONT ERROR(RMS): $\lambda/8$ @632.8 nm
6. AR COATING: V coating @405 nm,
(S1,S2,S3,S4): $R_{avg} < 0.25\%$ (6° AOI, SINGLE SURFACE)
7. CHAMFER: 45° , < 0.2 mm
8. SURFACE QUALITY(S1,S2,S3,S4): 20/10(S/D)
9. PARALLELISM(S1,S2,S3,S4): < 10 arcsec

DRAWING PROJECTION				LBTEK			
	NAME	DATE	QWPSM05-405B				
DRAWN	LZHOU	JUL./15th/24	QUARTZ ZERO-ORDER WAVEPLATE SM05, $\varnothing 10$ mm CA, $\lambda/4$, @405 nm				
APPROVAL	WCHENG	JUL./15th/24	MATERIAL	WEIGHT	SCALE	REV	
FOR INFORMATION ONLY NOT FOR MANUFACTURING PURPOSES			QUARTZ	3.7 g	5:2	B	