

NUMBER	PART DESCRIPTION	MATERIAL
①	WAVEPLATE	QUARTZ
②	GASKET	GASKET
③	O-RING	NITRILE
④	SM05R	BLACK ANODIZED ALUMINUM
⑤	MECHANICAL HOUSING	BLACK ANODIZED ALUMINUM

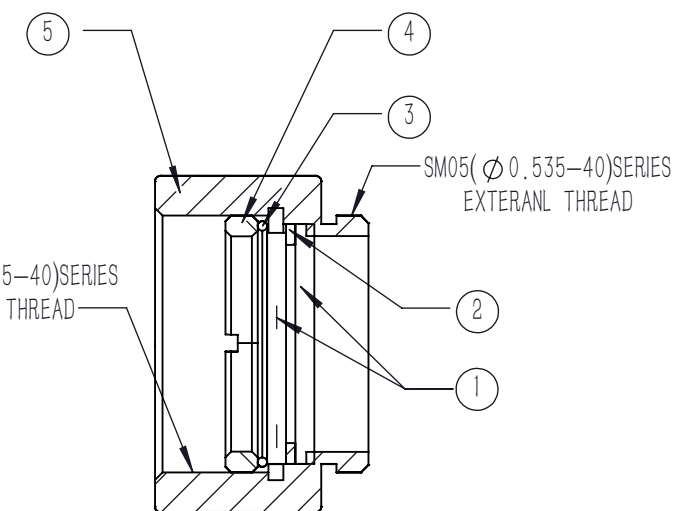

A-A

NOTES

- DESIGN WAVELENGTH: 532 nm
- CLEAR APERTURE: $\varnothing 10$ mm
- DELAY: $\lambda/4$
- DELAY TOLERANCE: $\pm \lambda/300$
- WAVEFRONT ERROR(RMS): $\lambda/8$ @632.8 nm
- AR COATING: V coating @532 nm,
(S1,S2,S3,S4): $R_{avg} < 0.25\%$ (6° AOI, SINGLE SURFACE)
- CHAMFER: 45° , < 0.2 mm
- SURFACE QUALITY(S1,S2,S3,S4): 20/10(S/D)
- PARALLELISM(S1,S2,S3,S4): < 10 arcsec

DRAWING PROJECTION				LBTEK			
	NAME	DATE	QWPSM05-532B				
DRAWN	LZHOU	JUL./15th/24	QUARTZ ZERO-ORDER WAVEPLATE SM05, $\varnothing 10$ mm CA, $\lambda/4$, @532 nm				
APPROVAL	WCHENG	JUL./15th/24	MATERIAL	WEIGHT	SCALE	REV	
FOR INFORMATION ONLY NOT FOR MANUFACTURING PURPOSES			QUARTZ	3.7 g	5:2	B	