

2.0mm [5/64in] HEX
2.5mm [0.10in] DEEP

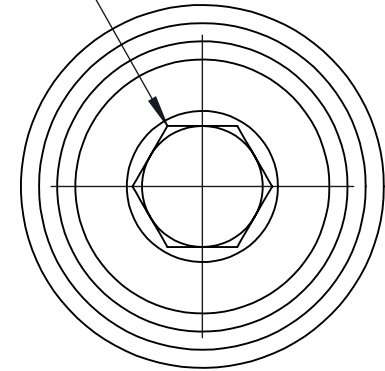

DRAWING PROJECTION			LBTEK			
	NAME	DATE				
DRAWN	PCHEN	Jan. /29th/26	M6 POST DOWEL ADAPTER			
APPROVAL	YHLI	Jan. /29th/26	MATERIAL	WEIGHT	SCALE	REV
FOR INFORMATION ONLY NOT FOR MANUFACTURING PURPOSES			N/A	0.002 Kg	8:1	A

FOR INFORMATION ONLY
NOT FOR MANUFACTURING PURPOSES