

SM05 (0.535"-40) SERIES
INTERNAL THREAD

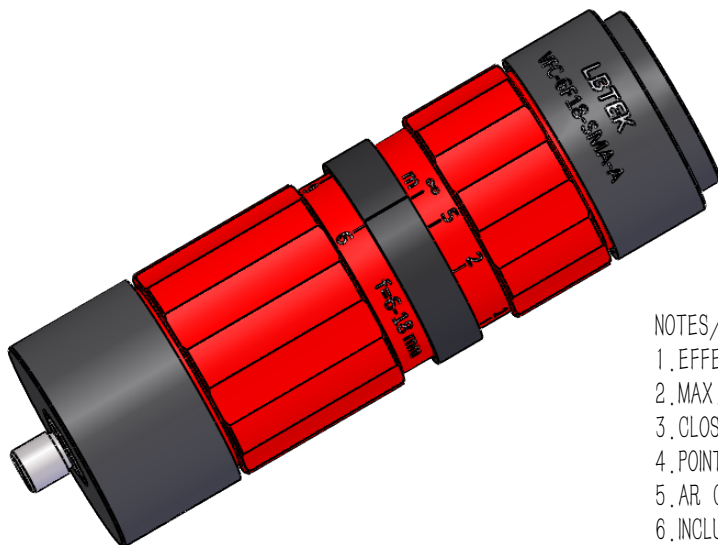
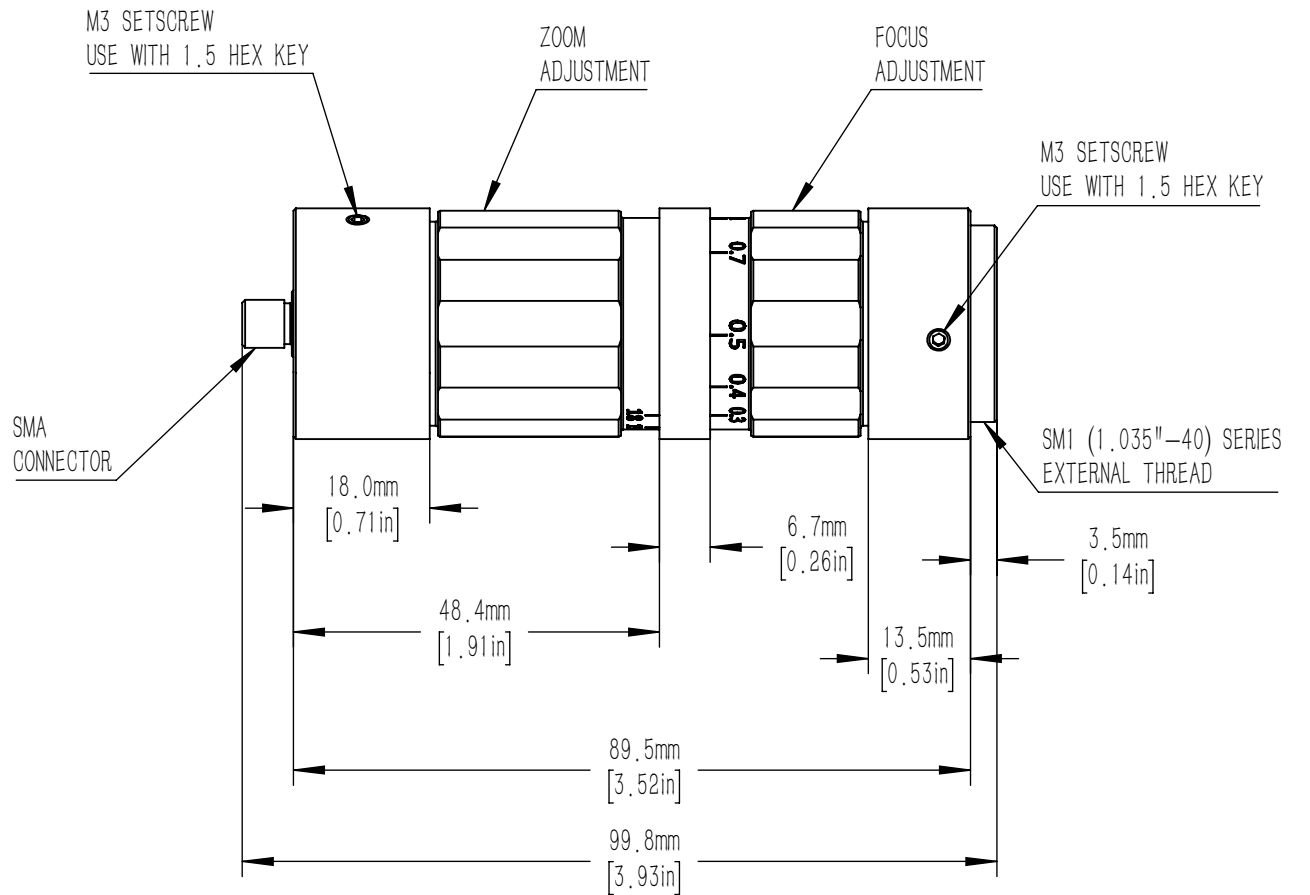
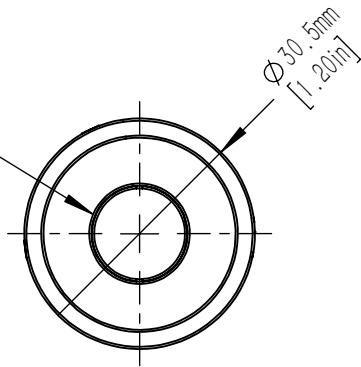

NOTES/SPECIFICATIONS:

1. EFFECTIVE FOCAL LENGTH: 6-18mm
2. MAX. FIBER NUMERICAL APERTURE: 0.25
3. CLOSEST FOCUSING DISTANCE: 0.3m
4. POINTING STABILITY DURING ZOOMING: <4mrad
5. AR COATING: $R_{avg} < 0.5\%$ for 400-650nm
6. INCLUDED BUT NOT SHOWN: 1.5 HEX KEY FOR LOCKING SCREWS

DRAWING PROJECTION			LBTEK			
	NAME	DATE				
DRAWN	JUS	MAR./6th/24	Zoom Collimator f=6-18mm			
APPROVAL	WEC	MAR./6th/24	MATERIAL	WEIGHT	SCALE	REV
FOR INFORMATION ONLY NOT FOR MANUFACTURING PURPOSES			N/A	0.181 Kg	1:1	A