

该点表明0°快轴方向

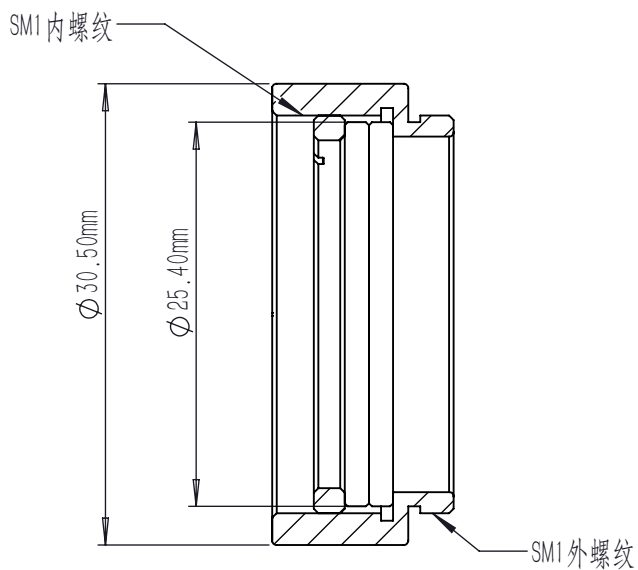

剖面 A-A

比例 2 : 1

注:

1. 光学材质: 液晶聚合物波片/N-BK7窗口片
2. 通光孔径:  $\phi 21.5\text{ mm}$
3. 设计波长: 1064 nm
4. 延迟量:  $\lambda/2$
5. 延迟量均匀性:  $\pm 5\text{ nm}$
6. m值:  $m=2$
7. 透过波前差 (@633):  $\lambda/4$
8. 直径公差:  $0.00/-0.05\text{ mm}$
9. 厚度公差:  $\pm 0.05\text{ mm}$
10. 增透膜: 700-1100 nm
11. 延迟量精度:  $\pm 5\text{ nm}$
12. 表面光洁度 (S/D): 40/20
13. 入射角 (AOI):  $\pm 20^\circ$
14. 机械外壳厚度: 12 mm
15. 机械外壳直径: 30.5 mm
16. 螺纹规格: SM1内外螺纹
17. 波片外径 (不含外壳):  $\phi 25.4\text{ mm}$



DRAWING PROJECTION			<b>LBTEK</b>			
	NAME	DATE	Vortex Retarder			
DRAWN	XLIU	MAY/16th/2022	MATERIAL	WEIGHT	SCALE	REV
APPROVAL	SHAN	MAY/16th/2022	LCP/N-BK7	0.01 kg	2:1	A
FOR INFORMATION ONLY NOT FOR MANUFACTURING PURPOSES						